

PAVEMENT MAINTENANCE SOLUTIONS

A complete overview of Striping
and Road Marking Spray Equipment



PROVEN QUALITY. LEADING TECHNOLOGY.

▶ ABOUT GRACO



▶ ABOUT GRACO

Graco is a world leader in fluid handling systems and is a renowned quality brand name with almost 100 years experience in moving, measuring, controlling, dispensing, mixing and applying a wide range of fluids and viscous materials. Processing food and cosmetics, applying coatings on walls, furniture, cars, boats, trains and airplanes, marking of lines on roads and sports fields, spraying insulation foam, sealing glass or gluing boxes, lubricating machinery – on-road or off-road, transferring chemicals from A to B, cleaning with high pressure... Graco's innovative technologies are designed to handle these fluids and enable you to achieve your application objectives successfully.

▶ STAY IN TOUCH



 **GRACO** | PAVEMENT MAINTENANCE

[Let Us Help](#)

[More from Graco](#) 

PAVEMENT MAINTENANCE SOLUTIONS

PAVEMENT MAINTENANCE

Every day, striping contractors have the daunting task to deliver high quality marking within the most **cost effective** deadlines. Since the introduction of our first airless line striper in 1990, Graco has developed an impressive range of solutions, based upon the specific needs of our customers. From airless paint to thermoplastic materials, from mechanical to hydraulic technologies and from walk-behind to ride-on concepts, our systems deliver! We understand that very often the **quality** of the finish is in the preparation. That's where our scarifier options come into the picture.

► **FIND MORE ADVICE:**

Discover more information, application articles, success stories and tips & tricks on www.graco.com/stripping.



▲ Click above

► **BE THE FIRST TO KNOW!**

The easiest way to stay up to date with our latest innovations is by subscribing to our LinkedIn channel. This platform shares new and relevant content from the field, announces new product features and gives you the chance to connect and to engage inside a community with industry peers.

Follow us NOW on Graco Pavement Solutions!



▲ Click above

► **SCARIFYING SOLUTIONS:**

Graco offers a total solution for all your scarifying applications as well with an expanded line of GrindLazers and cutters.

Download the GrindLazer catalogue here.



▲ Click above

► **CONTACT OUR EXPERTS ONLINE!**

Aiming at the best quality support, our specialised distributors are trained in providing professional local expertise.

**Can't find what you're looking for and you need more support?
Contact us!**



▲ Click above

► **GRACO PAVEMENT RANGE:**

Get to know all Graco pavement applications through our range video.

▶ INDEX

Every day, striping contractors have the daunting task to deliver high quality marking within the most cost effective deadlines. Since the introduction of our first airless line striper in 1990, Graco has developed an impressive range of solutions, based upon the specific needs of our customers. From airless paint, traffic tape to thermoplastic materials, from mechanical to hydraulic technologies and from walk-behind to ride-on concepts, our systems deliver! We understand that very often the quality of the finish is in the preparation.

Airless Line Striping



Airless painting technology is primarily known for its speed of application. In combination with sharp and crisp line definition, Graco's range of innovative LineLazer systems ensure high quality jobs within the most efficient timeframe.

▶ PAINT APPLICATIONS	08 - 67
LINELAZER™	08 - 55
FEATURES	10 - 21
UNITS	22 - 37
LineDriver™ - LineDriver HD	22
LineDriver ES	23
Stencil ES 500 - LineLazer™ ES 500	24
LineLazer ES 1000	26
LineLazer V ES 2000	27
LineLazer 3400	28
LineLazer V 3900 - LineLazer V 5900	29
LineLazer 130HS	30
LineLazer V 200HS	31
LineLazer V 200DC	32
LineLazer V 250SPS	34
LineLazer V 250DC	35
LineLazer V 200MMA 1:1	36
LineLazer V 250MMA 98:2	37
SPECIFICATIONS	38 - 49
ACCESSORIES	50 - 55
ROADPAK™	56 - 67
UNITS	56 - 57
RoadPak - RoadPak HD System	57
FEATURES	58 - 61
SPECIFICATIONS	62 - 63
ACCESSORIES	64 - 67

Thermoplastic Striping



In areas with heavy traffic, the durability of road marking is a key priority. Traffic control typically needs to reduce flow obstruction to a minimum. Using thermoplastic material has proven to increase significantly the long term quality of the line. The record drying time of this application contributes greatly to smooth traffic conditions. Technologies like Graco's on-board melting system and SmartDie applicators don't just simplify the process, they also offer the control you need of expected line thickness.

▶ THERMOPLASTIC APPLICATIONS	68 - 77
THERMOLAZER™	68 - 69
FEATURES	70 - 71
UNITS	72 - 75
ThermoLazer 200tc	73
ThermoLazer 300tc	74
ThermoLazer ProMelt	75
SPECIFICATIONS	76
ACCESSORIES	77

Traffic Tape Striping



Line visibility is important for road safety. Traffic tape materials are renowned for their high visibility and durability compared to other road marking materials. The best possible reflectivity is guaranteed and retained over the life of the tape making. The new TapeLazer combines key features from our industry-leading LineLazer V stripers with groundbreaking new technology to simplify traffic tape application.

▶ TAPE APPLICATIONS	78 - 83
TAPELAZER™	78 - 79
FEATURES	80 - 81
UNITS	82
TapeLazer HP automatic	82
SPECIFICATIONS	83
ACCESSORIES	83

Parts



Genuine Graco parts greatly contribute to a product's lifetime. Our set of OEM options add extra flexibility in building application specific systems.

▶ PARTS	84 - 97
OEM PARTS	87
TIPS & NOZZLES	88 - 92
HOSES	93
SWIVELS, ADAPTERS & NIPPLES	94 - 95
REPAIR PARTS	96 - 97

Warranty



WARRANTY	99
----------	----

▶ PAINT APPLICATIONS





LineLazer™

FEATURES

UNITS

- LineDriver
- LineDriver HD
- LineDriver ES
- Stencil ES 500
- LineLazer ES 500
- LineLazer ES 1000
- LineLazer V ES 2000
- LineLazer 3400
- LineLazer V 3900
- LineLazer V 5900
- LineLazer 130HS
- LineLazer V 200HS
- LineLazer V 200DC
- LineLazer V 250SPS
- LineLazer V 250DC
- LineLazer V 200MMA 1:1
- LineLazer V 250MMA 98:2

SPECIFICATIONS

ACCESSORIES

RoadPak™

FEATURES

UNITS

- RoadPak
- RoadPak HD

SPECIFICATIONS

ACCESSORIES

Enhancing Line Quality

▶ A.V.R.S. = Advanced Vibration Reduction System

Removes engine vibration and takes line quality to the next level.



without A.V.R.S.



with A.V.R.S.

How does it work?

Uneven road surfaces and a running engine produce vibrations. These are transferred to the striping gun(s) and thus prevent the gun(s) from maintaining a perfectly fixed angle over the surface

New Concept

Graco invents the AVRS system which reduces vibrations up to 60%. Less vibrations simply result in better quality lines

A.V.R.S.

Reduced vibration is achieved with an exclusive pump sprayer, a mounting system and a new single gun bar holder



▶ Rear Gun Mounting

Rear Gun Mounting

Photo on the right shows the result obtained when striping 2 lines simultaneously: one gun mounted at the front and a second at the rear. Same machine, same speed, same paint

Straighter Lines

Lining up the gun(s) with the two rear wheels and axles results in straighter lines

Front & Rear Mount

Mounting the gun at the front of the machine is a requirement to stripe up to the curb on a parking lot. However, for long line pavement applications, mounting the gun at the rear improves straightness and consistency of the lines

Easy

The rear gun mounting option eliminates the need to reverse the mount of the engine and the handle

▶ Easy Out™ Pump Filter



The easy out pump filter is designed to filter from the inside out:

- Filters won't get stuck or collapse when filled with direct or debris
- Large 125 cm² filtering area reduces tip clogs and ensures a quality finish
- Vertical filter removes with the cap for less mess

Endurance™ Pump: Prolonging Pump Life

► Graco's Long Life Chromex Endurance Pump sets the industry standard

- Handle the most demanding materials with long-life rod treatment and V-Max Blue™ packings
- Durable Chromex™ rod and stainless steel sleeve deliver superior reliability and life

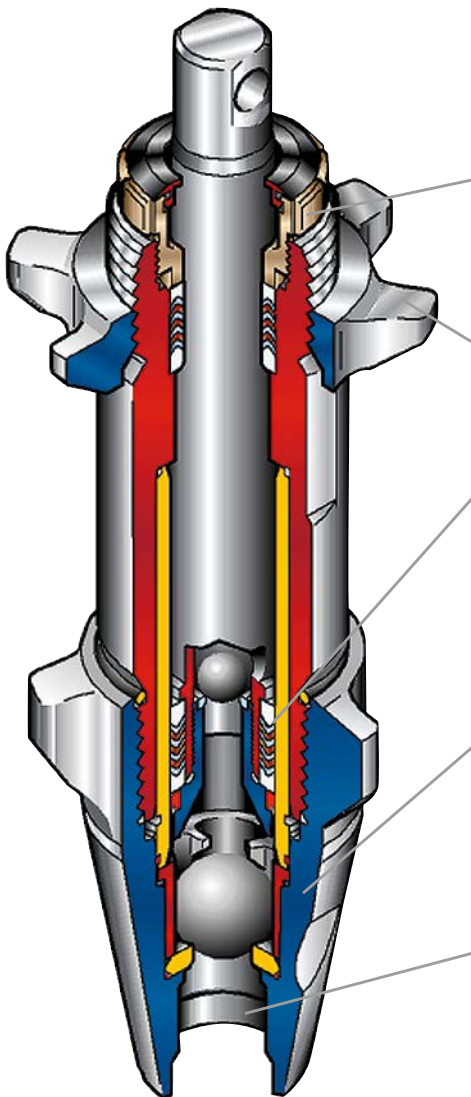

(A) Adjustable Packing Nut

- When the upper packings are worn out, paint leaks out and pressure drops
- With Graco, you can finish the job by tightening the nut instead of stopping for repair

(B) Quick Knock-Off™

- To remove the risk of downtime, replace the complete pump, on the job, in about 15 minutes

(C) "V"-Max Blue™ Packing

- Ultra High Molecular Weight Polyethylene material is compatible with solvent and water-based coatings
- V-Max Design means the packings constantly adjust to pressure and wear = longer lasting

(D) QuikAccess™

- Graco pumps are field serviceable with only a hammer and a wrench
- Access the inlet and outlet without downtime and costly repairs

(E) EasyFlow™

- All fluid passages (SST) are machined with smooth curves
- The less fluid frictions allow more flow and heavier coatings

LineLazer™ V Adjustment Systems

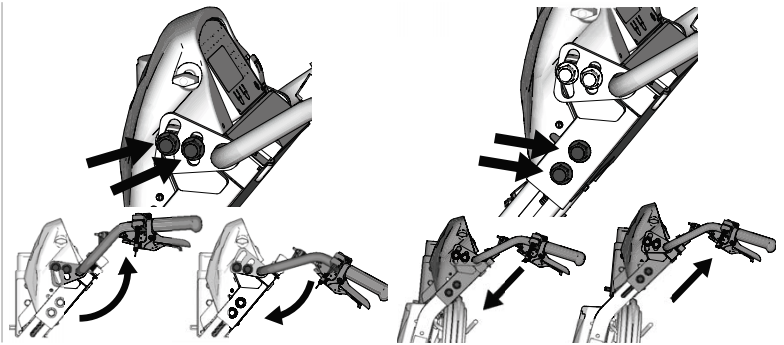

► DualComfort Handlebar System

Improved comfort for all day striping

- Easily adjust the handle bar angle and height
- Sturdy and solid design
- Perfect fit for all size users

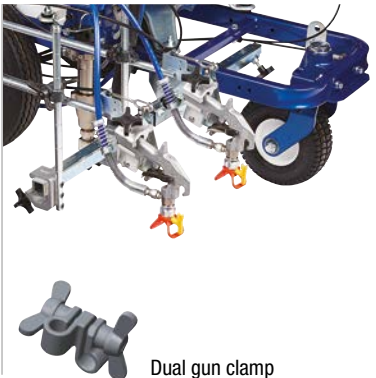

► EasyMark Gun Adjustment System

Gun Adjustment has never been easier

- Markings on gun bars for easy operation
- Removable “G-Clamp” is Industry-First
- New Dual Gun Clamp for solid gun control
- Provides perfect 2-gun alignment

PATENT PENDING



► EZ Align™ Wheel System

Improved Front Wheel Adjustment System

- Allows simple realignment of front wheel to maintain “straight” tracking
- No special tools needed to adjust
- Quick and easy “Fine Tune Adjustment”

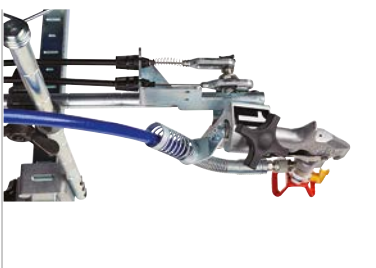

► HP Automatic Double Gun Trigger System

Manual or Automatic Gun control, you choose how to operate your guns!

- Individual gun control system
- Manual control via lever
- Automatic control via push button
- Direct AutoLayout via Auto Guns

See the manual of your LineLazer for more details and instructions

LineLazer™ V Adjustment Systems

▶ LineLazer V LiveLook Display with SmartControl™

LineLazer V comes delivered with an all new LiveLook Display, providing you all your striping information at a glance. The Standard Series allows you to track and show every aspect of your striping job while the HP Automatic Series offers you much more capabilities like Auto and Semi-Auto Guns, Jobsite Data Logging and AutoLayout™.



▶ LineLazer V Standard Series: ES 2000 - 3900 - 5900 - 200

Track, measure, and control every aspect of your striping job.

Set the unit to your preferred measurements, indicating volume in gallons or liters; pressure in psi, bar or MPa; distance in feet or meters which also changes line thickness in mils or microns and speed in mph or kph.

▶ LineLazer V HP Automatic Series: ES 2000 - 3900 - 5900 - 200 - 250

The HP Automatic Series comes equipped with Automatic guns allowing you to step up in the Road Marking business. Program your unit for automatic or semi-automatic skip-lines, Auto-Layout functionality with built-in parking lot calculators and much more.

▶ Main Screens

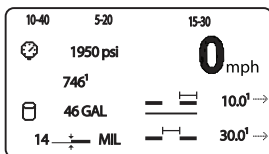

Main Striping Screen

- Speed
- Pressure
- Liters
- Line thickness
- Line width
- Skip line (HP Automatic and HP Reflective series)

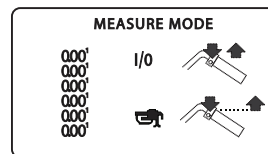

Measure Mode

Measure distances using your unit

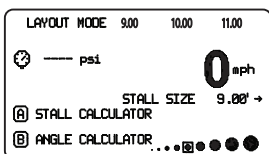

Layout Mode

(HP Automatic and HP Reflective Series)

- Premark your jobsite
- Lay out a parking lot
- Calculate straight parking lots
- Calculate angled parking lots

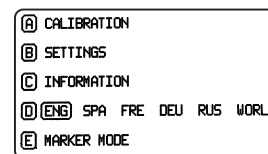

Settings/Information

- Calibrate your unit
- Set your preferences
- Unit Information
- Language settings
- Marker mode (HP Automatic and Reflective only)

▶ Calibration Screen

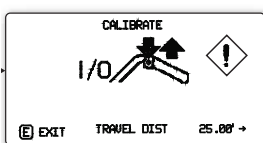

Calibrate your unit for accurate measurements on each jobsite:

- Speed indication
- Line Thickness calculation
- Measure Mode
- Auto guns (HP Automatic and HP Reflective Series)

See the manual of your LineLazer for more details and instructions

LineLazer™ V Adjustment Systems

▶ LineLazer V Automatic Guns

Putting down skip lines has never been easier with automatic guns. With Auto Mode and Semi-Auto Mode, you can control any skip line requirement on jobsites.

Striping truck features now on a walk-behind unit!

- Program guns to start and stop automatically to deliver perfect lines every time!
- Stripe skip lines with a simple push of a button
- Push button control eliminates hand lever fatigue
- Use semi-automatic mode for single lines with fixed lengths

Select the gun that you want to use



Activate the guns for spraying

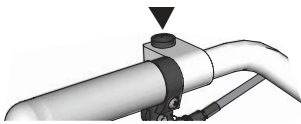

Automatic guns allow you to spray different types of road markings

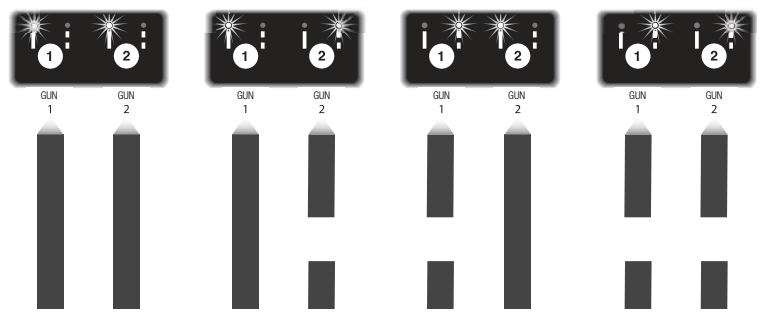

▶ LineLazer V AutoLayout II System

Whatever the requirements are for a parking lot layout, AutoLayout II on your LineLazer V HP Automatic or HP Reflective series can limit your manual measuring work and lay out the dots where you want it to directly from the gun.

Finish Jobs Faster

- Up to 30% faster with walk behind strippers
- Up to 50% faster when using the LineDriver attachment

Less Hassle, Less Fatigue

- No bending to mark the lines
- Eliminates the strain to read the tape measure
- Takes the hassle out of calculating distances and stall sizes
- Simple to use every time

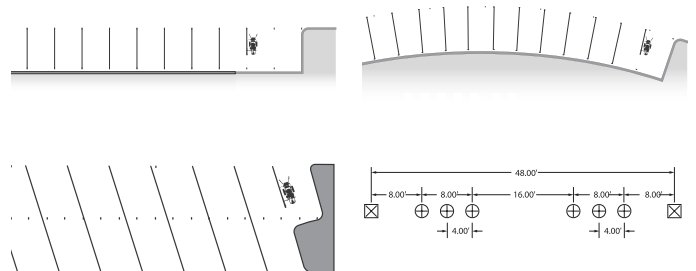

Screen Overview

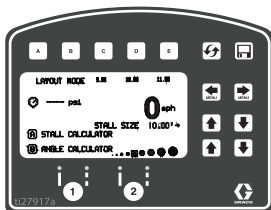

Layout Mode:

Use the Layout Mode screen for your Premark or Layout requirements.

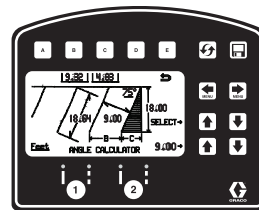

Angle Calculator:

Advance in parking lots and calculate the offset for angled parking lots helping you to lay out any parking lot design.

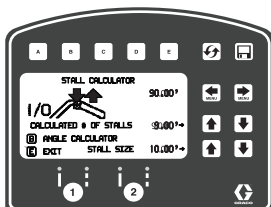

Stall Calculator

Preset your unit to lay out parking lots. Calculate the number of stalls or the stall size.

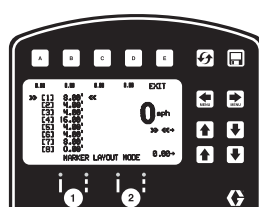

Marker Layout Mode:

Predefine marker layouts that do not have consistent distances in between.

LineLazer™ V Adjustment Systems

► J-Log System: Jobsite Data Logging

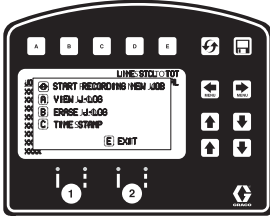

JOB	DATE	TIME	FEET	MIL	IN	OUT	IN	OUT
0001	25.12.2015	1:00	3:800	12	12.1	14.0	0.0	1.1
0001	25.12.2015	2:00	10:000	14	14.7	0.7	2.0	2.7
0001	25.12.2015	3:00	4:000	15	15.0	3.0	1.0	4.5
0002	25.12.2015	3:00	0	0	0	0.0	4.0	4.0
0002	25.12.2015	6:00	11:000	14	14.9	3.9	1.0	4.9
0002	25.12.2015	7:00	10:000	14	14.3	0.3	0.0	0.3
0003	25.12.2015	9:30	7:000	15	15.3	2.3	0.5	2.8
0003	25.12.2015	10:40	12:000	12	12.1	14.0	1.0	5.1

Track your jobsite data with your unit. Let the unit save data every hour or manually select the moment you need to save data.

Sub Menu Screens



Set your unit to your needs: time, pressure, volume, contrast, guns



Control your auto-guns with even more advanced gun settings:

- Shut off your guns at low speeds
- Start you skip lines with paint or space

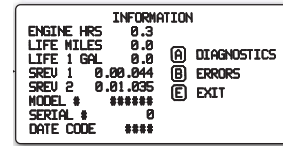

Control in depth information of your unit and check software revision and error codes.

► World Symbols for LineLazer V LiveLook Display

LineLazer V LiveLook Display is equipped with a World Symbols feature which can be used in any language.

STRIPING MODE	MEASURE MODE	LAYOUT MODE	SETTINGS/DATA	DATA LOGGING
<p>M S A MANUAL OR AUTOMATIC MODE</p> <p> PRESSURE</p> <p> GALLONS/LITERS</p> <p> LINE THICKNESS</p> <p> PAINT LENGTH</p> <p> SPACE LENGTH</p> <p> LINE WIDTH</p> <p> EXIT</p> <p> YELLOW</p> <p> WHITE</p> <p> BLACK</p> <p> BLUE</p> <p> GREEN</p> <p> RED</p> <p> BATTERY LOW</p> <p> BATTERY CHARGING</p>	<p> PRESS TO START/STOP</p> <p> HOLD TO SPRAY A DOT</p>	<p> STALL CALCULATOR</p> <p> ANGLE CALCULATOR</p> <p> STALL WIDTH</p> <p> DOT SIZE SELECTOR</p>	<p> CALIBRATE</p> <p> SETTINGS</p> <p> UNITS</p> <p> INFORMATION & LIFE DATA</p> <p> MARKER LAYOUT MODE</p> <p> GUN SETTINGS</p> <p> SPECIFIC GRAVITY</p> <p> ENGINE HOURS</p> <p> TOTAL DISTANCE</p> <p> TOTAL GALLONS</p> <p> SOFTWARE REV</p> <p> ERROR CODES</p> <p> CONTRAST</p> <p> DIAGNOSTICS</p> <p> TIME AND DATE</p> <p> LOW SPEED SHUTOFF</p>	<p> START RECORDING NEW JOB</p> <p> JOBS</p> <p> TIME STAMPS</p> <p> SCROLL</p> <p> DELETE</p> <p> DISTANCE PAINTED</p> <p> GALLONS OF LINE PAINTED</p> <p> GALLONS OF STENCIL PAINTED</p> <p> TIME AND DATE</p> <p> TOTAL GALLONS/LITERS</p>

Exclusive Electric Striping Solutions

► FULL POWER & PERFORMANCE WITH DEWALT LITHIUM BATTERIES

- Achieve unlimited run time with swappable high-capacity FlexVolt™ batteries
- Delivered complete with two batteries for continuous stenciling and striping
- Fan-cooled fast charger recharges one battery under 60 minutes

**NO ENGINE NOISE,
NO ENGINE FUMES,
NO ENGINE VIBRATION!**



Stencil ES 500

LineLazer ES 500

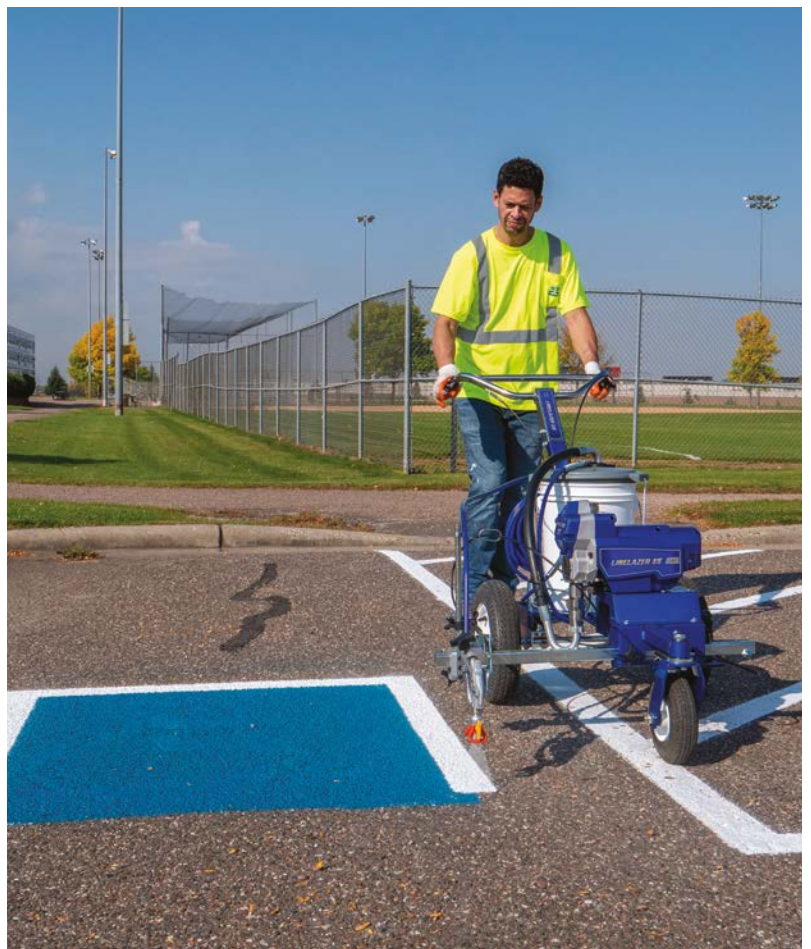

Exclusive Electric Striping Solutions

► FULL POWER & PERFORMANCE WITH HIGH-CAPACITY LITHIUM BATTERIES

- Enough power to stripe all day
- Up to 4000 recharges
- Reduced weight versus AGM batteries



LineLazer ES 1000



LineLazer V ES 2000



Exclusive Electric Striping Solutions

► Fume-free, noise-free, and vibration-free performance

Only Graco offers a complete line of electric striping solutions designed to deliver quiet, fume-free performance on indoor jobs, and the power to tackle large outdoor applications.



LINELAZER ES 1000
PATENT PENDING

- The industry's first battery-powered stripper
- No engine noise, vibration, or fumes
- High-capacity battery with onboard 12 V charger
- Simply plug in to recharge
- Run on 230 V wall power - just plug it in



**LINELAZER V ES 2000
STANDARD SERIES**
PATENT PENDING

- Get your job done faster
- Higher output
- Supports 2-gun operation
- LiveLook Display



**LINELAZER V ES 2000
HP AUTOMATIC SERIES**
PATENT PENDING

- Automatic paint gun system
- Simplify layout and skip line work
- Job performance tracking
- J-Log System with USB download



**MAXIMUM ELECTRIC STRIPING PRODUCTIVITY
LINEDRIVER™ ES** PATENT PENDING

- No engine noise, vibration, or fumes
- More accurate lines with the ExactMil™ speed control and low vibration
- Get the job done fast with the electric, battery-powered LineDriver ES

Exclusive Electric Striping Solutions



NO ENGINE NOISE

Do any job anytime, without disruptive engine noise.

NO ENGINE FUMES

Enables you to stripe indoors without production shut downs or disruptions.

NO ENGINE VIBRATION

Allows for perfect lines on all surfaces and reduces user fatigue.



Typical Applications

FACTORIES & WAREHOUSES

INDOOR STRIPING where exhaust fumes are not allowed

PARKING GARAGES

Where exhaust fumes and noise can be a concern in **ENCLOSED ENVIRONMENTS**

NIGHTTIME

OUTDOOR STRIPING where noise can be a concern, like on parking lots, paths, intersections and airports

SPORTS FIELD MARKING

For **PAINTING LINES AND LOGOS** on sports fields

Product covered by issued and pending patents, see graco.com/us/en/patents.

Battery Powered LineLazer™ EPOWER Series



▶ 100 Ah Lithium Battery

No Exhaust Fumes – No Noise

- Maintenance Free
- Holds up well to vibrations
- Reduced weight versus AGM batteries
- Fast recharge time and up to 4000 recharges per battery
- Spray up to 110 liters with one battery and up to 325 liters with 2 batteries
- Monitor status of each battery via smartphone



▶ On-Board 230 to 12 V Charger

Plugs into 230 V wall-power

- No external charger needed, only extension cable
- Simple recharge, just plug it in
- Voltage display while using and charging

▶ 230 V Capability

Infinite spray time

- Spray while plugging in to 230 V wall-power
- Even when battery is depleted
- Use as a stationary sprayer, ideal for stencil jobs



▶ Easy Access Controls

Manage your unit at the handle bar

- On-off switch for pumping system
- Pressure Control with ECO-Mode for optimal battery usage
- LiveLook Display with unit and jobsite information on ES 2000
- Storage space on ES 1000



LineDriver™ - LineDriver™ HD

Ride-On System

Why walk when you can ride? Graco LineDriver and LineDriver HD attachments connect to your LineLazer striper to provide the most innovative, user-friendly ride-on systems available to double your striping productivity.

FlexBeam™ LED Light System

- LED light for improved brightness with long life and less amp draw
- Retractable, breakaway design prevents damage and keeps you striping

Ride with Ease

- Adjustable dual foot pedals to fit every user
- Forward and reverse capability

Exclusive ProStart™ Engine Starting System

- Up to 50% less pulling effort to start the engine
- Outperforms other starting systems in cooler weather

Cool-Comfort™ Seat

- Grey colour stays cool in direct sunlight
- High-back seat for added support
- Extra padding for all-day comfort

Reliable, easy-to-start Honda® Engine

- Contractor preferred due to its power and proven reliability



Dual Foot Pedal System



LineDriver 160

LineDriver™ ES

Electric Battery-Powered Ride-On System

Why walk when you can ride? The Graco LineDriver ES is the quietest, most innovative, user-friendly ride-on system. Simply connect the LineDriver ES to your LineLazer striper to double your striping productivity on any indoor or outdoor job, without the engine noise, fumes and vibration.

High-Speed Production Efficiency

- 16 kph (10 mph) maximum speed
- 10-14 hours of run time

Quiet, All-Day Reliable Power

- Three 24 V, 50 Ah Lithium batteries
- Up to 4000 recharges
- Bluetooth monitoring
- 3-Year warranty

Consistent Lines Every Time

- Fix your speed for guaranteed consistent, perfect lines every time with the ExactMil™ Speed control
- Exactly meet the mil thickness requirement, resulting in quality work with no wasted paint
- Speed boost mode allows for faster speeds between lines to increase your productivity

Superior Control and Extended Run-Time

- Performance and feel of a Gas-powered LineDriver
- Regenerative braking recharges batteries to extend run-time
- Eco-mode allows up to 14 full hours of run time and precise control at low speeds

Simple, Plug-In Charging - Onboard 230 to 24 V Charger

- Onboard 230 to 24 V charger
- Longer battery life with extended battery-tender feature

Easy Accessory Charging

- Dual "cigarette lighter" power supplies for all your accessories
- Dual LED light outputs
- Dedicated 12 V Power Supply

Battery Monitor System

- Displays battery level for easy recall
- Alerts user when battery is low and requires a recharge

On-Hand Storage

- Convenient back Rack Storage Shelf for on-the-job supplies

* PATENT PENDING



LineDriver ES

Stencil ES 500 - LineLazer™ ES 500

Battery-Powered Walk Behind Striper



LineLazer™ ES 500



Stencil ES 500



Swappable batteries

► Applications & Materials

The LineLazer ES 500 is a fully-capable line striper for those small to medium-sized restripe jobs, while introducing the benefits of battery-powered technology. Designed specifically for fast-dry traffic paints, the battery-powered Stencil ES 500 is the perfect addition to any striping contractors' fleet to do stenciling work in comfort. Both units come with two DeWALT batteries and a fast charger that enables you to work virtually continuously!

► Features & Benefits

No engine noise, Exhaust fumes and Vibration

- Complete your job with improved jobsite conditions without interruption
- Reduce user fatigue while delivering perfect lines

Quiet, reliable Power

- Achieve unlimited run time with swappable high-capacity DEWALT FlexVolt™ batteries
- Stripe immediately up to 38 liters* with two fully charged batteries
- Delivered complete with two batteries for continuous stenciling and striping
- Fan-cooled fast charger recharges battery in under 60 minutes

Easier Maneuverability

- Front swivel wheel allows to stripe right up to the curb and makes easy work of hard-to-do curves
- Tapered locking pin design provides years of dependable operation

EasyMark™ Gun Adjustment System

- Simple guide mark system
- Easy gun on/off, front/back
- Perfect gun set up every time

Handlebar Design

- Adjustable design, allows for optimal ergonomics and reduced vibration on your hands or all-day striping comfort.
- Contoured grips comfortably fit your hands

Rear Mount Hose Wrap

- Provides easy on/off for stenciling applications

* Up to 23 liters using the Stencil ES 500



LineLazer™ ES 1000

Battery-Powered Mechanical Walk Behind Striper



LineLazer™ ES 1000



Battery Compartment



Built-In Charger

► Applications & Materials

Striping without exhaust fumes or noise? Powered by a high-output Lithium battery, the LineLazer ES 1000 is safe to use indoors while having the power and performances needed for all jobs.

► Features & Benefits

No engine noise, Exhaust fumes and Vibration

- Complete any job at any time without production shutdowns or disruptions
- Reduce user fatigue while delivering perfect lines on all indoor and outdoor surfaces

Quiet, reliable Power

- Maintenance-free 12 V, 100 Ah Lithium battery
- Stripe up to 110 liters per charge
- Add a second battery and get up to 325 liters per charge

On-Board 230V Charger

- Simply plug in to recharge using the built-in charger system
- Get infinite spray time when using for stationary applications by running on 230 V wall power

Exclusive LineLazer™ Frame

- Industry's best-balanced chassis allows for straighter lines
- Accepts LineDriver, 55 liter hopper, EZ Bead™ system, pointer, LaserGuide systems and LED light

DualComfort™ Handlebar System

- Fits all users and easy to adjust
- Solid 4-bolt design

EZ Align™ Front Wheel System

- Simple front wheel alignment keeps unit tracking straight
- Intuitive design without needing any special tools

EasyMark™ Gun Adjustment System

- Simple guide mark system
- Easy gun on/off, front/back
- Perfect gun set up every time

See page 20 for more detail

LineLazer™ V ES 2000

Battery-Powered Mechanical Walk Behind Striper



LineLazer™ V ES 2000



LineDriver ES



LiveLook Display

► Applications & Materials

Need more output, dual gun capability and features from a battery-powered LineLazer? The LineLazer V ES 2000 is powered by the same high-output Lithium battery as the ES 1000 and is available as a Standard and HP Automatic series striper.

► LineLazer V Features & Benefits

No engine noise, Exhaust fumes and Vibration

- Complete any job at any time without production shutdowns or disruptions
- Reduce user fatigue while delivering perfect lines on all indoor and outdoor surfaces

Quiet, reliable Power

- 2 maintenance-free 12 V, 100 Ah Lithium battery
- Stripe immediately up to 325 liters per charge

LiveLook™ Display with SmartControl™

- Track, measure and control every aspect of your job
- Real-time information for the perfect lines

EZ Align Front Wheel System

- Simple front wheel alignment keeps unit tracking straight
- Intuitive design without needing any special tools

Includes all Standard Series Features PLUS:

► LineLazer V HP Automatic Series Features & Benefits

Automatic Paint Gun System

- Push button control for lower operator fatigue and accurate (skip-)lines
- Manual, semi- and automatic guns/mode

Auto-Layout™ II

- SmartControl™ measures while you walk and puts down pre-marks
- No need for measuring tape or string lines cutting
- Cuts your parking lot layout time in half

Valuable job information with J-Log System

- Onboard job information for proof of completion
- USB download allows you to capture all job data

See page 39 for more detail on 1- and 2-gun offering in Standard and HP Automatic Series

LineLazer™ 3400

Mechanical Walk Behind Striper



LineLazer™ 3400



Front Swivel Wheel



Stencilling

► Applications & Materials

The LineLazer 3400 is the preferred choice for contractors who are looking for professional performance in a 1-gun striper. This striper is ideal for parking lots and seal coating contractors, schools, park and recreation departments.

► Features & Benefits

Handlebar Design

- Adjustable design, allows for optimal ergonomics and reduced vibration on your hands or all-day striping comfort.
- Contoured grips comfortably fit your hands

Updated Frame

- 7 cm longer for greater stability and straighter lines
- Now accepts 55 liter hopper and EZ Bead™ system

Easier Maneuverability

- Front swivel wheel allows to stripe right up to the curb and makes easy work of hard-to-do curves
- Tapered locking pin design provides years of dependable operation

EasyMark Gun Adjustment System

- Simple guide mark system
- Easy gun on/off, front/back
- Perfect gun set up every time

Rear Mount Hose Wrap

- Provides easy on/off for stenciling applications

Electronic Pressure Control

- Accurate, tight tolerance system provides excellent line quality

See page 40 for more detail

LineLazer™ V 3900 - LineLazer™ V 5900

Mechanical Walk Behind Stripers



LineLazer™ V 5900



LineLazer™ V 3900

► Applications & Materials

The LineLazer V 3900 is the airless line striping choice for professional striping contractors who want the industry's best striping unit. The LineLazer V 5900 continues to be the mid to heavy-duty striping solution for professional contractors who recognize the increased productivity this leader delivers.

► Features & Benefits

LiveLook™ Display with SmartControl™

- Track, measure and control every aspect of your job
- Real-time information for the perfect lines

DualComfort™ Handlebar System

- Fits all users and easy to adjust
- Solid 4-bolt design

EZ Align Front Wheel System

- Simple front wheel alignment keeps unit tracking straight
- Intuitive design without needing any special tools

EasyMark Gun Adjustment System

- Simple guide mark system
- Easy gun on/off, front/back
- Perfect gun set up every time

► Includes all Standard Series Features PLUS: Features & Benefits

Automatic Paint Gun System

- Push button control for lower operator fatigue and accurate (skip-)lines
- Manual, semi- and automatic guns/mode

Auto-Layout™ II

- SmartControl™ measures while you walk and puts down pre-marks
- No need for measuring tape or string lines cutting
- Cuts your parking lot layout time in half

Valuable job information with J-Log System

- Onboard job information for proof of completion
- USB download allows you to capture all job data

OnBoard Power

- 12V battery for all your accessory items

See page 40-43 for more detail on 1- and 2-gun offering in Standard and HP Automatic Series

LineLazer™ 130HS

Hydraulic Walk Behind Striper



LineLazer™ 130HS

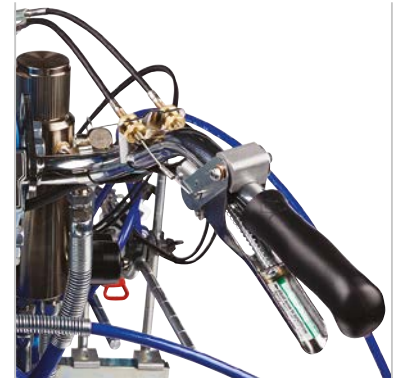

► Applications & Materials

The LineLazer 130HS is the ultimate hydraulic airless striping unit that contractors rely on for their most challenging striping jobs. Professional striping contractors wanting hydraulic performance and proven power cannot go wrong with the LineLazer 130HS.

► Features & Benefits

Storage Compartment

- Convenient storage area for tips, guards and miscellaneous items

DualComfort™ Handlebar System

- Fits all users and easy to adjust
- Solid 4-bolt design

EZ Align Front Wheel System

- Simple front wheel alignment keeps unit tracking straight
- Intuitive design without needing any special tools

EasyMark Gun Adjustment System

- Simple guide mark system
- Easy gun on/off, front/back
- Perfect gun set up every time

QuickSelect Gun Selector

- Independently control two guns with one chrome gun lever

Honda Power

- Contractor preferred due to its power and proven reliability
- Oil Alert shuts down engine to prevent damage if oil level drops too low

Exclusive Easy Out Filter System

- 50 mesh filter for no plug performance
- Inside-out design means less mess and fewer tip clogs

Rear Gun Mount System

- Place the guns near the rear axle for straighter long lines and smoother curved lines

See page 40 for more detail on 1- and 2-gun offering

LineLazer™ V 200Hs

Hydraulic Walk Behind Striper



LineLazer™ V 200Hs



LineLazer™ V 200Hs HP Reflective

► Applications & Materials

The LineLazer V 200Hs is the high performance hydraulic striper you'll want for your most demanding jobs. It's proven history of innovative features has made it the striper of choice for contractors demanding a true workhorse. The LineLazer V 200Hs is the perfect unit for large parking lot jobs, airports, and city jobs that not only require precise lines but also demand reflective beads.

► Includes all Standard Series Features PLUS: **Features & Benefits**

Automatic Paint Gun System

- Push button control for lower operator fatigue and accurate (skip-)lines
- Manual, semi- and automatic guns/mode

Auto-Layout™ II

- SmartControl™ measures while you walk and puts down pre-marks
- No need for measuring tape or string lines cutting
- Cuts your parking lot layout time in half

Valuable job information with J-Log System

- Onboard job information for proof of completion
- USB download allows you to capture all job data

Onboard Power

- 12V battery for all your accessory items

► Includes all HP Automatic Series Features PLUS: **Features & Benefits**

Pressurized Bead System

- Onboard closed compressor avoids dust and debris from entering
- Ensures proper bead flow and paint penetration
- Large volume bead tank holds up to 54kg
- Bead gun activates automatically with spray gun
- Bead gun with gun-delay ability
- Adjustable nozzle for bead dispensing width adjustment

See page 40-46 for more detail on 1- and 2-gun offering in Standard, HP Automatic and HP Reflective Series

LineLazer™ V 200dc

Hydraulic Dual Colour Walk Behind Striper



LineLazer™ V 200dc



LineLazer™ V 200DC Standard

► Applications & Materials

The LineLazer V 200DC offers you Dual Colour Capability in a push-behind hydraulic airless striping unit. Offered in Standard, HP Automatic and HP Reflective series, the LineLazer V 200DC offers you two units in one. Take one unit to a two-colour jobsite and get the job done faster! As a bonus you'll save on transport compared to transporting two units for individual colours.

LINELAZER V 200DC includes same features as LineLazer V200HS PLUS:

► Features & Benefits

Dual-Colour Capable

- Dual colour applications with a single unit improves efficiency and profitability

Dual Graco Hydraulic Motors

- No-stall hydraulic design provides uninterrupted performance

Dual Endurance Piston Pumps

- Long life pumps provide precise flow for a wide range of striping materials

Dual 38 liter Hoppers

- Extended striping time with large capacity hoppers

Onboard Power

- 12V battery for all your accessory items

See page 40-46 for more detail on 1- and 2-gun offering in Standard, HP Automatic and HP Reflective Series



LineLazer™ V 250sps

Hydraulic Ride-On Striper



LineLazer V 250sps *HP Automatic*



LineLazer V 250sps *HP Reflective*

► Applications & Materials

High performance, self-propelled striping with automatic paint guns makes the LineLazer V 250sps the preferred striper for professional contractors who demand more. This striper is ideal for large, heavy-duty line striping jobs including parking lots and road jobs.

► Features & Benefits

Automatic Paint Gun System

- Push button control for lower operator fatigue and accurate (skip-)lines
- Manual, semi- and automatic guns/mode

Exclusive Stand-On Platform

- Integrated platform provides an ergonomic place for standing, great view and all-day comfort

Self-Centering Front Wheel

- Eliminates one user interface for simpler operation
- Foam filled for stability

EasyMark Gun Adjustment System

- Simple guide mark system
- Easy gun on/off, front/back
- Perfect gun set up every time

► Includes all HP Automatic Series Features PLUS: Features & Benefits

Pressurized Bead System

- Onboard closed compressor avoids dust and debris from entering
- Ensures proper bead flow and paint penetration
- Large volume bead tank holds up to 54kg
- Bead gun activates automatically with spray gun
- Bead gun with gun-delay ability
- Adjustable nozzle for bead dispensing width adjustment

See page 40-46 for more detail on 1- and 2-gun offering in HP Automatic and HP Reflective Series

LineLazer™ V 250dc

Hydraulic Dual Colour Ride-On Striper



HP AUTOMATIC
SERIES

HP REFLECTIVE
SERIES

LineLazer V 250dc HP Automatic



LineLazer V 250dc HP Reflective

► Applications & Materials

Spray two colours simultaneously with Graco's new LineLazer V 250dc. Ideally suited for airports, municipalities, DOTs or anyone who needs to spray highlight lines or other dual-colour striping.

► Features & Benefits

Dual-Colour Capable

- Dual colour applications with a single unit improves efficiency and profitability

Dual Graco Hydraulic Motors

- No-stall hydraulic design provides uninterrupted performance

Dual Endurance Piston Pumps

- Long life pumps provide precise flow for a wide range of striping materials

EasyMark Gun Adjustment System

- Simple guide mark system
- Easy gun on/off, front/back
- Perfect gun set up every time

► Includes all HP Automatic Series Features PLUS: Features & Benefits

Pressurized Bead System

- Onboard closed compressor avoids dust and debris from entering
- Ensures proper bead flow and paint penetration
- Large volume bead tank holds up to 54kg
- Bead gun activates automatically with spray gun
- Bead gun with gun-delay ability
- Adjustable nozzle for bead dispensing width adjustment

See page 40-46 for more detail on 2- and 3 gun offering in HP Automatic and HP Reflective Series

LineLazer™ V 200MMA 1:1

Hydraulic Walk Behind 2-Component 1:1 Striper



LineLazer V 200MMA 1:1
(unit shown includes optional LazerGuide 1700)

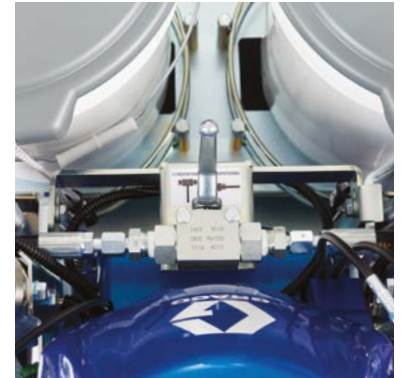

1:1 Hydraulic Proportioner



Air-Purge Fusion Gun

► Applications & Materials

The Graco LineLazer 200MMA 1:1 delivers superior performance that guarantees ratio assurance with a 1:1 hydraulic proportioner and an Fusion Air-Purge gun from Graco, a +10 year industry proven 2-component internal mixing gun with Air-Purge flushing capability. No need to carry solvent during the jobsite, the gun is purged using compressed air.

► Features & Benefits

LINELAZER V 200MMA 1:1 includes same features as LineLazer V200DC HP Reflective PLUS:

Dual Graco Hydraulic Motors

- No-stall hydraulic design provides uninterrupted performance

Dual Endurance Piston Pumps

- Long life pumps provide precise flow for a wide range of striping materials

Dual Paint Bucket Holder

- Extended striping time with large 55 liter capacity buckets

Precise MMA 1:1 Ratio

- Innovative Flow Divider guarantees equal material flow of each component
- Built-in bypass valve for independent pump operation

Graco Fusion™ Air-Purge Gun mixes materials “at the gun”

- Instant air purge after every line, or disable for purging after last skip-line
- Clears all material in the mixing chamber and eliminates buildup of material on the tip
- Quick-release fluid housing lets you easily change mix chamber without tools
- RAC® 5 SwitchTips™ for easy clearing of a tip clog

See page 40-46 for more detail on 1- and 2-gun offering in Standard, HP Automatic and HP Reflective Series

LineLazer™ V 250MMA 98:2

Hydraulic Ride-On 2-Component 98:2 Striper

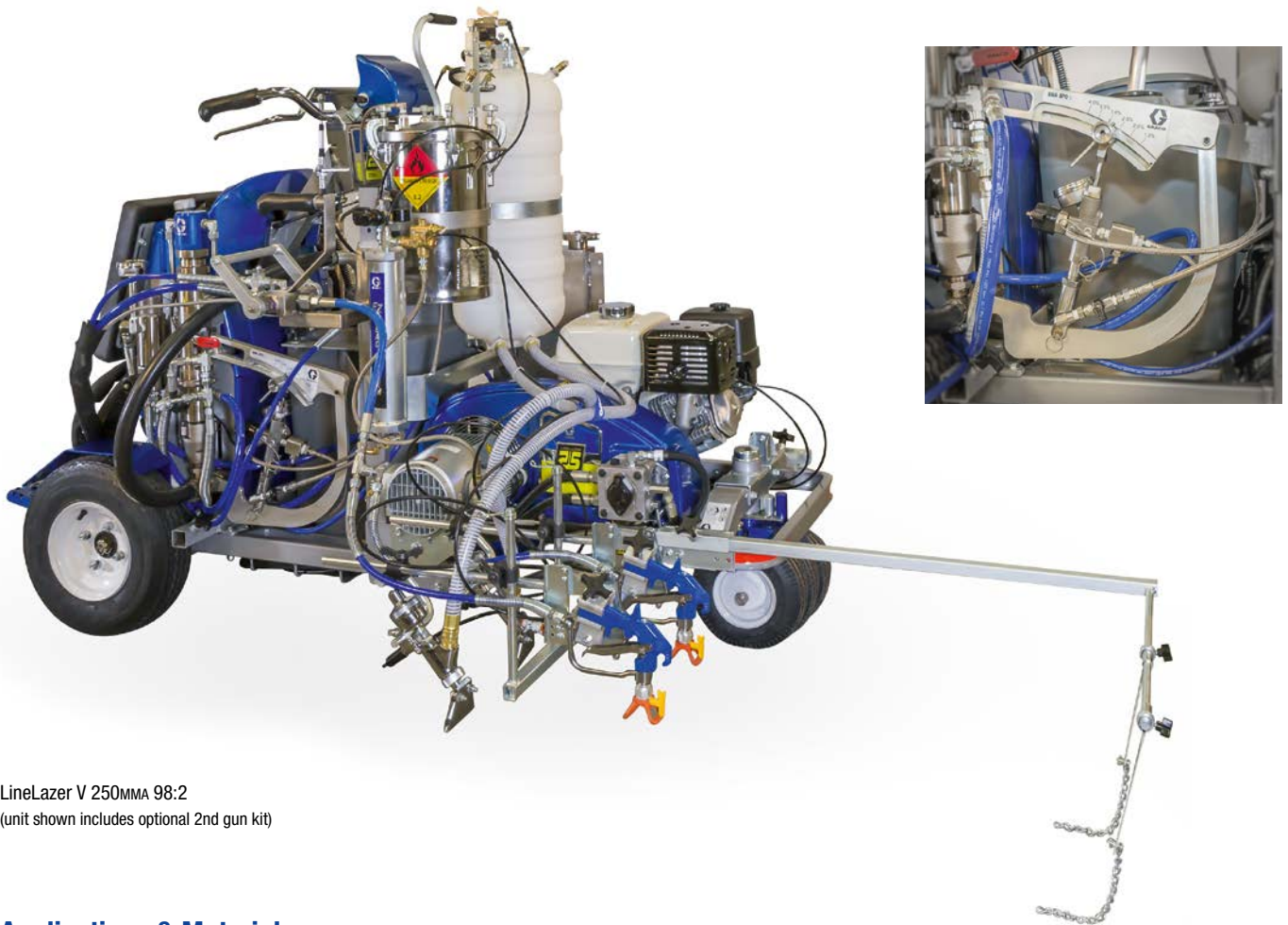

LineLazer V 250MMA 98:2
(unit shown includes optional 2nd gun kit)

► Applications & Materials

Spraying 2-component 98:2 road markings has never been more reliable with LineLazer V 250MMA 98:2. Based upon the LineLazer V 250 range, this unit provides it all: built in 98:2 mixing capabilities and Ratio Assurance, on-board storage tanks and solvent flushing capabilities.

► Features & Benefits

Automatic Paint Gun System

- Push button control for lower operator fatigue and accurate (skip-)lines
- Manual, semi- and automatic guns/mode

Exclusive Stand-On Platform

- Integrated platform provides an ergonomic place for standing, great view and all-day comfort

Self-Centering Front Wheel

- Eliminates one user interface for simpler operation
- Foam filled for stability

EasyMark Gun Adjustment System

- Simple guide mark system
- Easy gun on/off, front/back
- Perfect gun set up every time

Pressurized Bead System

- Installed and ready to go
- Ensures proper bead flow and paint penetration

Exclusive 98:2 Mixing System

- On-Board storage tanks for MMA, BPO and solvent
- Exclusive hard-connect MMA and BPO pump design
- Engineered for superior ratio control, from 1.5 to 4.0%
- Integrated mix hose for consistency in material mixing
- Ratio assurance system and mix-manifold for outstanding performance

57 Liter MMA Hopper

- Extended striping time with large capacity hopper along with 7 Liter of BPO pressure pot

Solvent Flush System

- 7 Liter solvent reservoir connected to an endurance piston pump provides pressurized flushing capability of manifold, hose assembly and gun

Ratio Assurance System

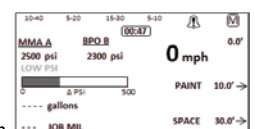

See page 46 for more detail

Specifications

UNITS - BATTERY-POWERED SERIES



Stencil ES 500



LineLazer ES 500



LineLazer ES 1000



SPECIFICATIONS	Stencil ES 500	LineLazer ES 500	LineLazer ES 1000
Part Number – 1 mech gun	25U514	25U547	25U675
Part Number – 2 mech guns	-	-	-
Part Number – 1 auto gun	-	-	-
Part Number – 1 auto + 1 mech gun	-	-	-
Part Number – 2 auto guns	-	-	-
Max. Tip Size – 1 gun	0.021"	0.021"	0.025"
Max. Tip Size – 2 guns	-	-	-
Max. Flow – l/min. (gpm)	1.8 (0.47)	1.8 (0.47)	2.3 (0.6)
Max. Pressure – bar (PSI)	227 (3300)	227 (3300)	227 (3300)
Battery Power – Volt (Ah)	2 x 54V DeWALT® FlexVolt® battery (6.0)	2 x 54V DeWALT® FlexVolt® battery (9.0)	12 V Lithium (100)
Weight – kg (lbs)	14 (31)	55 (121)	131 (288)
FEATURES			
LiveLook Display			
Hydraulic Pressure gauge	✓	✓	✓
SmartControl™			✓
FastFlush™			✓
Endurance™ Pump	Mechanical	Mechanical	Mechanical
EZ Align™ System			✓
EasyMark System		✓	✓
QuickSelect™ Gun Selector			Manual
Rear-gun Mounted			✓
DualComfort™ Handle bar system			✓
ProConnect	✓	✓	✓
LineDriver Compatible*			Optional
COMPOSITION			
Tips	286419	LL5317 LL5419	LL5319 LL5421
Guard	RAC V (243161)	RAC V (243161)	RAC V (243161)
Gun	Flex Plus™ (248157)	Flex Plus™ (248157)	Flex Plus™ (248157)
Extension	40 cm (223718)	-	-
Hose	BlueMax™ II 1/4" x 15 m (249080)	BlueMax™ II 1/4" x 15 m (249080)	BlueMax™ II 1/4" x 15 m (249080)
Pump Filter	60 mesh (243984)	60 mesh (243984)	60 mesh (243984)
Power Supply	2 x 54V DeWALT® FlexVolt 6.0 ah battery with DeWALT® Fan-cooled fast charger	2 x 54V DeWALT® FlexVolt 9.0 ah battery with DeWALT® Fan-cooled fast charger	1x 12 V battery with 230 V inverter incl. 30 cm cable set (EU,IT,DK,CH,UK)
TSL	118ml (238049)	118ml (238049)	118 ml (238049)

* See page 22-23 and 56 for more information on all LineDriver units.

LineLazer V ES 2000

LineLazer V ES 2000



	25U681	-
	25U685	-
	-	25U682
	-	25U687
	-	25U686
	0.033"	0.033"
	0.025"	0.025"
	4.1 (1.1)	4.1 (1.1)
	227 (3300)	227 (3300)
	2x 12 V Lithium (100)	2x 12 V Lithium (100)
	165 (364)	171 (377)
	✓	✓
	✓	✓
	Mechanical	Mechanical
	✓	✓
	✓	✓
	Manual	Automatic + Manual
	✓	✓
	✓	✓
	Optional	Optional
	LL5319	LL5319
	LL5421	LL5421
	RAC V (243161)	RAC V (243161)
	Flex Plus (248157)	Flex Plus (248157)
	-	-
	BlueMax™ II 3/8" x 6.7 m (124884)	BlueMax™ II 3/8" x 6.7 m (124884)
	50 mesh (24V455)	50 mesh (24V455)
	2 x 12 V battery with 230 V inverter incl. 30 cm cable set (EU, IT, DK, CH, UK)	2 x 12 V battery with 230 V inverter incl. 30 cm cable set (EU, IT, DK, CH, UK)
	118 ml (238049)	118 ml (238049)

Specifications

UNITS - STANDARD SERIES



LineLazer 3400



LineLazer 130hs



LineLazer V 3900



SPECIFICATIONS				
Part Number – 1 mech gun	25M224	17H447	17H449	
Part Number – 2 mech guns	-	17H448	17H450	
Max. Tip Size – 1 gun	0.027"	0.037"	0.035"	
Max. Tip Size – 2 guns	-	0.029"	0.025"	
Max Flow – l/min. (gpm)	2.8 (0.75)	4.9 (1.3)	4.7 (1.25)	
Max. Pressure – bar (PSI)	227 (3300)	227 (3300)	227 (3300)	
Motor Rating – cm ³	120	120	120	
Weight – kg (lbs)	72.5 (160)	119 (263)	104 (230)	
FEATURES				
LiveLook Display			✓	
Endurance Pump	Mechanical	Hydraulic	Mechanical	
AVRS		✓	✓	
EZ Align System		✓	✓	
EasyMark System	✓	✓	✓	
Quick Select Gun Selector		Manual	Manual	
Rear-gun Mounted		✓	✓	
DualComfort Handlebar System		✓	✓	
LineDriver Compatible*		Optional	Optional	
COMPOSITION				
Tips	LL5317	LL5319	LL5319	
	LL5319	LL5421	LL5421	
Guard	RAC V (243161)	RAC V (243161)	RAC V (243161)	
Gun	Flex Plus gun (248157)	Flex Plus gun (248157)	Flex Plus gun (248157)	
Hose	BlueMax™ II 1/4" x 15 m (249080)	BlueMax™ II 3/8" x 6.7 m (124884)	BlueMax™ II 3/8" x 15 m (245225)	
Pump Filter	60 mesh (243984)	50 mesh (24V455)	50 mesh (24V455)	
Fuel Capacity - L (gal)	2.5 (0.66)	2.5 (0.66)	2.5 (0.66)	
TSL	118 ml (238049)	118 ml (238049)	118 ml (238049)	

* See page 22-23 and 56 for more information on all LineDriver units.

LineLazer V 5900

LineLazer V 200hs

LineLazer V 200dc



	17H454	17H459	-
	17H455	17H461	17Y231
	0.043"	0.047"	0.047"
	0.029"	0.033"	0.033"
	6.0 (1.6)	8.14 (2.15)	8.14 (2.15)
	227 (3300)	227 (3300)	227 (3300)
	160	200	200
	113 (250)	139 (306)	173 (381)
	✓	✓	✓
	Mechanical	Hydraulic	Hydraulic
	✓	✓	✓
	✓	✓	✓
	✓	✓	✓
	Manual	Manual	Manual
	✓	✓	✓
	✓	✓	✓
	Optional	Optional	Optional
	LL5319	LL5319	LL5319
	LL5421	LL5421	LL5421
	RAC V (243161)	RAC V (243161)	RAC V (243161)
	Flex Plus gun (248157)	Flex Plus gun (248157)	Flex Plus gun (248157)
	BlueMax™ II 3/8" x 15 m (245225)	BlueMax™ II 3/8" x 6.7 m (124884)	BlueMax™ II 3/8" x 3.6 m (191239)
	50 mesh (24V455)	50 mesh (24V455)	50 mesh (24V455)
	3.6 (0.95)	3.6 (0.95)	3.6 (0.95)
	118 ml (238049)	118 ml (238049)	118 ml (238049)

Specifications

UNITS - HP AUTOMATIC SERIES



LineLazer V 3900



LineLazer V 5900



LineLazer V 200hs



SPECIFICATIONS				
Part Number – 1 auto gun	17K577	17K580	17K582	
Part Number – 1 auto + 1 mech gun	17K638	17K636	17K637	
Part Number – 2 auto guns	17K579	17K581	17K583	
Part Number – 3 auto guns	-	-	-	
Max. Tip Size – 1 gun	0.035"	0.043"	0.047"	
Max. Tip Size – 2 guns	0.025"	0.029"	0.033"	
Max. Tip Size – 3 guns	-	-	-	
Max Flow – l/min. (gpm)	4.7 (1.25)	6.0 (1.6)	8.14 (2.15)	
Max. Pressure – bar (PSI)	227 (3300)	227 (3300)	227 (3300)	
Motor Rating – cm ³	120	160	200	
Weight – kg (lbs)	109 (240)	121 (266)	146 (322)	
FEATURES				
LiveLook Display	✓	✓	✓	
Endurance Pump	Mechanical	Mechanical	Hydraulic	
AVRS	✓	✓	✓	
EZ Align System	✓	✓	✓	
EasyMark System	✓	✓	✓	
DualComfort Handlebar System	✓	✓	✓	
Quick Select Gun Selector	Automatic + Manual	Automatic + Manual	Automatic + Manual	
Rear-gun Mounted	✓	✓	✓	
LineDriver Compatible*	Optional	Optional	Optional	
COMPOSITION				
Tips	LL5319	LL5319	LL5319	
	LL5421	LL5421	LL5421	
Guard	RAC V (243161)	RAC V (243161)	RAC V (243161)	
Gun	Flex Plus gun (248157)	Flex Plus gun (248157)	Flex Plus gun (248157)	
Hose	BlueMax™ II 3/8" x 15 m (245225)	BlueMax™ II 3/8" x 15 m (245225)	BlueMax™ II 3/8" x 6.7 m (124884)	
Pump Filter	50 mesh (24V455)	50 mesh (24V455)	50 mesh (24V455)	
Fuel Capacity - L (gal)	2.5 (0.66)	3.6 (0.95)	3.6 (0.95)	
TSL	118 ml (238049)	118 ml (238049)	118 ml (238049)	

* See page 22-23 and 56 for more information on all LineDriver units.

LineLazer V 200oc

LineLazer V 250sps

LineLazer V 250oc



-	17H466	-
-	-	-
17Y232	17H467	17H471
-	-	17H472
0.047"	0.055"	0.055"
0.033"	0.039"	0.039"
-	0.031"	0.031"
8.14 (2.15)	9.5 (2.5)	9.5 (2.5)
227 (3300)	227 (3300)	227 (3300)
200	390 - Electric Start	390 - Electric Start
180 (397)	302 (666)	341 (752)
✓	✓	✓
Hydraulic	Hydraulic	Hydraulic
✓	✓	✓
✓	✓	✓
✓	✓	✓
✓	✓	✓
Automatic + Manual	Automatic	Automatic
✓	✓	✓
Optional	Self Propelled System	Self Propelled System
LL5319	LL5321	LL5321
LL5421	LL5425	LL5425
	LL5627	LL5627
RAC V (243161)	RAC V (243161)	RAC V (243161)
Flex Plus gun (248157)	Flex Plus gun (248157)	Flex Plus gun (248157)
BlueMax™ II 3/8" x 3.6 m (191239)	BlueMax™ II 3/8" x 3.6 m (191239)	BlueMax™ II 3/8" x 3.6 m (191239)
	BlueMax™ II 1/4" x 2.1 m (245798)	BlueMax™ II 1/4" x 2.1 m (245798)
50 mesh (24V455)	50 mesh (24V455)	50 mesh (24V455)
3.6 (0.95)	5.3 (1.4)	5.3 (1.4)
118 ml (238049)	118 ml (238049)	118 ml (238049)

Specifications

UNITS - HP REFLECTIVE SERIES



LineLazer V 200hs



LineLazer V 200bc



SPECIFICATIONS			
Part Number – PBS 1 auto gun	17J964	-	
Part Number – PBS 2 auto guns	17K585	17Y233	
Part Number – PBS 3 auto guns	-	-	
Part Number – PBS 1 mech gun	17H460	-	
Part Number – PBS 2 mech gun	-	17Y648	
Max. Tip Size – 1 gun	0.047"	0.047"	
Max. Tip Size – 2 guns	0.033"	0.033"	
Max. Tip Size – 3 guns	-	-	
Max Flow – l/min. (gpm)	8.14 (2.15)	8.14 (2.15)	
Max. Pressure – bar (PSI)	227 (3300)	227 (3300)	
Motor Rating – cm ³	200	200	
Weight – kg (lbs)	189 (417)	223 (492)	
FEATURES			
LiveLook Display	✓	✓	
Endurance Pump	Hydraulic	Hydraulic	
AVRS	✓	✓	
EZ Align System	✓	✓	
EasyMark System	✓	✓	
Quick Select Gun Selector	Automatic + Manual	Automatic + Manual	
Rear-gun Mounted	✓	✓	
Bead Tank	1 Bead Tank	1 Bead Tank	
Bead Guns	17J964 – 1 bead gun		
	17K585 – 2 bead guns	17Y233 - 2 bead guns	
	17H460 – 1 bead gun	17Y648 - 2 bead guns	
DualComfort Handlebar System	✓	✓	
LineDriver Compatible*	Optional	Optional	
COMPOSITION			
Tips	LL5319	LL5319	
	LL5421	LL5421	
Bead Nozzle	.234 (238666)	.234 (238666)	
	.281 (238664)	.281 (238664)	
Guard	RAC V (243161)	RAC V (243161)	
Gun	Flex Plus gun (248157)	Flex Plus gun (248157)	
Hose	BlueMax™ II 3/8" x 6.7 m (124884)	BlueMax™ II 3/8" x 3.6 m (191239)	
Pump Filter	50 mesh (24V455)	50 mesh (24V455)	
Fuel Capacity - L (gal)	3.6 (0.95)	3.6 (0.95)	
TSL	118 ml (238049)	118 ml (238049)	

* See page 22-23 and 56 for more information on all LineDriver units.

** Part 17J951 has one PBS tank and 17H469 has two PBS tanks.

LineLazer V 250sps

LineLazer V 250oc



	17H468	-
	17J951 + 17H469**	17H473
	-	17H474
	-	-
	-	-
	0.055"	0.055"
	0.039"	0.039"
	0.031"	0.031"
	9.5 (2.5)	9.5 (2.5)
	227 (3300)	227 (3300)
	390 - Electric Start	390 - Electric Start
	352 (778)	392 (864)
	✓	✓
	Hydraulic	Hydraulic
	✓	✓
	✓	✓
	Automatic	Automatic
	✓	✓
	1 bead tank (17H468)	2 bead tanks
	1 bead tank (17J951)	
	2 bead tanks (17H469)	
	17H468 - 1 bead gun	17H473 - 2 bead guns
	17J951 - 2 bead guns	17H474 - 3 bead guns
	17H469 - 2 bead guns	
	Self Propelled System	Self Propelled System
	LL5321	LL5321
	LL5425	LL5425
	LL5627	LL5627
	.234 (238666)	.234 (238666)
	.281 (238664)	.281 (238664)
	RAC V (243161)	RAC V (243161)
	Flex Plus gun (248157)	Flex Plus gun (248157)
	BlueMax™ II 3/8" x 3.6 m (191239)	BlueMax™ II 3/8" x 3.6 m (191239)
	BlueMax™ II 1/4" x 2.1 m (245798)	BlueMax™ II 1/4" x 2.1 m (245798)
	50 mesh (24V455)	50 mesh (24V455)
	5.3 (1.4)	5.3 (1.4)
	118 ml (238049)	118 ml (238049)

Specifications

UNITS - 2-COMPONENT

LineLazer V 200MMA 1:1



LineLazer V 250MMA 98:2

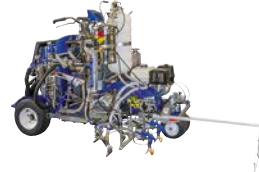

SPECIFICATIONS		
Part Number - PBS 1 Auto Gun	17Y234	17G589
Part Number - PBS 2 Auto Guns	17Y513	-
Max. Tip Size – 1 gun	0.047"	0.055"
Max. Tip Size – 2 guns	0.033"	0.039"
Max. Tip Size – 3 guns	-	0.031"
Max Flow – l/min. (gpm)	8.14 (2.15)	9.5 (2.5)
Max. Pressure – bar (PSI)	227 (3300)	207 (3000)
Motor Rating – cm ³	200	390 - Electric Start
Weight – kg (lbs)	251 (554)	405 (893)
FEATURES		
LiveLook Display	✓	✓
MMA Pump	Hydraulic	Hydraulic
BPO Pump	-	Hydraulic
Mix Ratio Assurance System	Hydraulic 1:1 Proportioner	✓
Mixing System	Air-Purge Fusion gun with internal mixing	Mix Hose
Solvent Tank + Pump	-	On-Board
AVRS	✓	✓
EasyMark System	✓	✓
Quick Select Gun Selector	Automatic + Manual	Automatic
Rear-gun Mounted	✓	✓
Bead Tank	1 bead tank	1 bead tank
Bead Guns	1 bead gun	1 bead gun
DualComfort Handlebar System	✓	-
LineDriver Compatible*	Optional	Self Propelled System
COMPOSITION		
Tips	286427	LL5321
	286631	LL5425
	286835	LL5627
Bead Nozzles	.234 (238666)	.234 (238666)
	.281 (238664)	.281 (238664)
Guard	RAC V (243161)	RAC V (243161)
Gun	Fusion gun (25E471)	HD Blue Texture gun (289605)
Hose	BlueMax™ II 3/8" x 6.7 m (124884)	MMA BlueMax™ II 3/8" x 6.7 m (124884)
	-	BPO Hose 1/4" x 5.8 m (17K367)
Mix Hose	-	Hose 3/8" x 50 cm (17H058)
Whip Hose	-	BlueMax™ II 1/4" x 55 cm (249149)
Pump Filter	50 mesh (24V455)	50 mesh (24V455)
Fuel Capacity - L (gal)	3.6 (0.95)	5.3 (1.4)
TSL	118 ml (238049)	118 ml (238049)

* See page 22-23 and 56 for more information on all LineDriver units.

Specifications

UNITS - RIDE-ON SYSTEMS



LineDriver 160**



LineDriver HD 200**



LineDriver ES



SPECIFICATIONS			
Part Number	262004	262005	25U671
Motor Engine cc (hp)	160 cm ³	200 cm ³	3x 24 V, 50 Ah Lithium
Fuel Capacity L (gal)	3.6 (0.95)	3.6 (0.95)	-
Weight kg (lb)	120 (266)	125 (277)	174 (384)

*All LineDriver units can be used on the LineLazer, ThermoLazer and the HP GrindLazer

**All LineDrivers are delivered without battery kit (245343) and hitch kit (245321/25N787/25R505)

Exclusive LazerGuide Solutions

► More Profits, less Setup Time

LazerGuide 2000 Laser-Guided Layout System

- Easy, one-person laser-quality line production to improve productivity and eliminate the need for tape measures, string, or chalk.



Traditional Method:
Requires a string line, chalk and 2 people

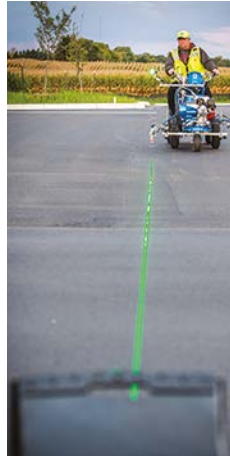

LazerGuide 2000 Method:
No string line, no chalk and 1 person

Higher Productivity

Stop wasting time with strings, tape measures, and chalk

Less Labour

One-person parking lot striping

Less Fatigue

No more kneeling down to move string lines or measuring tapes

Simple Operation

Just line it up with the target box and go

Accurate Striping

Straight lines every time - even in windy conditions

► Stripe Straighter than ever - Simply Point and Stripe

LazerGuide 2000 Laser-Guided Layout System

- 1) Place the LazerGuide Target Box
- 2) Line Up the LazerGuide 2000
- 3) Stripe



Parking Lots



Intersections



Athletic Fields



Exclusive LazerGuide Solutions

► Easier, Laser-straight Lines

LazerGuide 3000 Long-line Laser

- Replace your clunky mechanical pointer to improve your productivity and accuracy for airports, roads, large intersections, or anywhere a straight line is needed.



Longer Distance Accuracy

Extend reference point up to 10 meter - not possible with a mechanical pointer

Highly Visible Laser Guide

Quickly locate the laser on all surfaces with Blink Mode

Safer Operation

Laser is in your natural field of view

Faster, Simple Operation

Increase your manoeuvrability with no mechanical pointer in the way
Just line it up and go without the need to get off the machine



► Accurate Starts/Stops

LazerGuide 1700 Start/Stop Laser

- Improve the quality of your line by ensuring that your start and stop points are exactly where you want them to be. Pair with the LazerGuide 2000 or 3000 for the best possible results.

► Stripe with Laser Accuracy

LazerGuide 1700 Start/Stop Laser

- Line up the LazerGuide 1700 Start/Stop Laser directly under your spray tip to ensure accurate start/stop locations when striping, resulting in perfect lines every time.

LineLazer™ Accessories

**PART
NUMBER** **DESCRIPTION**

GUN AND HOSE KITS



248157	FLEXPLUS STRIPING GUN WITH LL5319 TIP
245225	LINELAZER BLUEMAX™ II HOSE WITH E-NICKEL FITTINGS (3/8" X 15 M - 227 BAR)
245798	LINELAZER BLUEMAX™ II HOSE WITH E-NICKEL FITTINGS (1/4" X 2 M - 227 BAR) (2 ND GUN HOSE)
249080	COUPLED BLUEMAX™ II HOSE (1/4" X 15 M) (LINELAZER ES, 3400)
124884	LINELAZER BLUEMAX™ II HOSE WITH E-NICKEL FITTINGS (3/8" X 6.7 M - 227 BAR) (LINELAZER IV/V 130HS, 200HS, 250MMA 98:2)
191239	LINELAZER BLUEMAX™ II HOSE WITH E-NICKEL FITTINGS (3/8" X 3.6 M - 227 BAR) (LINELAZER IV/V 250SPS/250DC)

PAINT GUN KITS

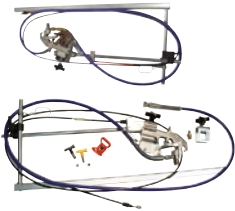

25A676	COMPLETE KIT FOR ADDING 2 ND MECHANICAL GUN (LINELAZER 130HS)
25A491	COMPLETE KIT FOR ADDING 2 ND MECHANICAL GUN (LINELAZER V 3900/5900/200, ES)
25A673	COMPLETE KIT, WITH SOLENOID FOR ADDING 2 ND AUTO GUN (LINELAZER V HP AUTOMATIC 3900/5900/200)
25A492	COMPLETE KIT, WITHOUT SOLENOID FOR ADDING 2 ND AUTO GUN (LINELAZER V HP AUTOMATIC 3900/5900/200)
17K791	COMPLETE KIT FOR ADDING EXTRA AUTO GUN (LINELAZER V 250SPS/250DC)
287553	COMPLETE KIT FOR ADDING 2 ND GUN (LINELAZER III 3900/5900, LINELAZER IV)
24M679	COMPLETE KIT FOR ADDING 2 ND GUN (LINELAZER IV 250)
24P930	COMPLETE KIT FOR ADDING 3 RD OR 4 TH GUN (LINELAZER IV 250)
24G778	PAINT GUN STENCIL KIT (LINELAZER V 250) INCLUDES: (1) PAINT GUN, (1) 1/4" X 15 M BLUEMAX™ II HOSE AND MOUNTING BRACKETS

2-COMPONENT

25U454	STATIC MIXER (LINELAZER 200MMA 1:1)
25N796	COMPLETE KIT FOR ADDING 2 ND FUSION AND BEAD GUN (LINELAZER V 200MMA 1:1)
289605	HD BLUE TEXTURE GUN (LINELAZER V 250MMA 98:2)
17K367	BPO HOSE 1/4" X 5.8 M, METAL BRAIDED (LINELAZER V 250MMA 98:2)
277481	SOLVENT HOSE 1/4" x 7.6 M
17H058	MIX HOSE, 50 CM WITH STATIC MIXING ELEMENTS (LINELAZER V 250MMA 98:2)
17K319	COMPLETE KIT FOR ADDING 2 ND AUTO GUN (EXCL. BEAD GUN KIT) (LINELAZER V 250MMA 98:2)
17H095	MANIFOLD MIXER, COMPLETE (LINELAZER V 250MMA 98:2)
17H093	BPO SLAVE PUMP KIT (LINELAZER V 250MMA 98:2)

LineLazer™ Accessories

LINELAZER POINTERS



PART NUMBER	DESCRIPTION
277062	SHORT POINTER GUIDE, 60 CM
277063	LONG POINTER GUIDE, 100 CM
24N162	ADJUSTABLE POINTER GUIDE, 100 CM (LINELAZER 250)
25A620	RETRACTABLE POINTER, 100 CM (LINELAZER V 130/3900/5900/200, ES)
24Y511	5-PACK HOSE REPLACEMENT (FOR 25A620 RETRACTABLE POINTER)
17P782	LAZERGUIDE 1700, GREEN DOT, WITHOUT BATTERY KIT (LINELAZER ES)
25A530*	LAZERGUIDE 1700, GREEN DOT, WITHOUT BATTERY KIT (LINELAZER V HP AUTO 3900/5900/200)
25A691	LAZERGUIDE 1700, GREEN DOT, WITHOUT BATTERY KIT (LINELAZER 250)
17T543	LAZERGUIDE 2000, GREEN LINE, WITHOUT BATTERY KIT (LINELAZER ES)
17T540	LAZERGUIDE 2000, GREEN LINE, WITHOUT BATTERY KIT (LINELAZER V HPAUTO 3900/5900/200)
17W270	LAZERGUIDE 2000, GREEN LINE, WITHOUT BATTERY KIT (LINELAZER 250)
17U800	LAZERGUIDE 2000, GREEN LINE, WITH BATTERY/CHARGER KIT (LINELAZER 3400, ES 500)
17T541	LAZERGUIDE 2000, GREEN LINE, WITH BATTERY/CHARGER KIT (LINELAZER V STANDARD 3900/5900/200)
17T545	LAZERGUIDE 2000, GREEN LINE, WITH BATTERY/CHARGER KIT (LINELAZER IV)
17V405	LAZERGUIDE 3000, BIG GREEN DOT, WITHOUT BATTERY KIT (LINELAZER V HP AUTO 5900/200)
17T542	LAZERGUIDE 3000, BIG GREEN DOT, WITHOUT BATTERY KIT (LINELAZER 250)

PAINT HOPPERS



17H171	HOPPER 5 L (STENCIL ES 500)
17P444	HOPPER 55 L (LINELAZER 3400, ES 500/1000)
241104	HOPPER 55 L (LINELAZER 130/3900/5900/200)
25N710	HOPPER 55 L (LINELAZER V ES 2000)
278720	HOPPER 55 L (1 PIECE SPLIT DESIGN FOR LINELAZER IV/V 250dc, 250mma 98:2)
278452	HOPPER 95 L HIGH CAPACITY (LINELAZER IV/V 250sps)
24V781	DUAL PLASTIC HOPPER COVER KIT (2 PIECES LINELAZER IV/V 250dc)
25N622	DUAL 38 L HOPPER COMPLETE KIT (LINELAZER V 200dc, 200mma 1:1) INCLUDES: 2 HOPPERS, 2 COVERS, 2 GROMMETS AND SUCTION TUBE EXTENSIONS
24V782	DUAL 55 L HOPPER COMPLETE KIT (LINELAZER IV/V 250dc) INCLUDES: 2 HOPPERS, 2 COVERS, 2 GROMMETS AND ALL HARDWARE
25N603	DUAL PAINT BUCKET HOLDER (LINELAZER 200dc) FOR USING TWO STANDARD PAINT BUCKETS
24U244	DUAL PAINT BUCKET HOLDER (LINELAZER 250dc)

*To mount a LazerGuide 1700 kit to the LineLazer 3400 or LineLazer ES 500, add parts 17T408, 17V737, 17U801 and 111145.

LineLazer™ Accessories

	PART NUMBER	DESCRIPTION	
PRESSURIZED EZ BEAD SYSTEM			
	25R271	PBS CLOSED COMPRESSOR KIT (LINELAZER V 200)	
	25R272	PBS CLOSED COMPRESSOR KIT (LINELAZER V 250)	
	25R268	PBS 1-BEAD GUN KIT (LINELAZER V 200)	
	25R267	PBS 2-BEAD GUN KIT (LINELAZER V 200)	
	25R270	PBS 1-BEAD GUN KIT (LINELAZER V 250)	
	25R269	PBS 2-BEAD GUN KIT (LINELAZER V 250)	
	16R963	PBS EXTRA BEAD GUN KIT (LINELAZER IV/V 200 _{HS} , LINELAZER IV/V 250)	
	238957	HAND BEAD STENCIL KIT (PBS SYSTEM REQUIRED) INCLUDES: (1) BEAD GUN, (2) 3/4" X 7.5 M CLEAR HOSES, .234"/.35 DEGREE TIP, 30 CM EXTENSION TUBE AND MOUNTING BRACKETS	
	19B119	GLASS BEADS SPRAY GUN KIT (PBS SYSTEM REQUIRED) INCLUDES: (1) BEAD GUN, (2) 3/4" x 1,25 M HOSE AND FITTINGS	
	16U439	PBS BEAD TANK KIT	
	17V103	BEAD GUN NOZZLE .170	
	238663	BEAD GUN NOZZLE .203	
	238666	BEAD GUN NOZZLE .234	
	238664	BEAD GUN NOZZLE .281	
	238665	BEAD GUN NOZZLE .344	
	243668	BEAD GUN NOZZLE .420	
	GRAVITY EZ BEAD SYSTEM		
		277064	15 CM 2-BEAD DISPENSER KIT (LINELAZER ES 1000/2000, IV/V 3900/5900/130/200)
24M838		15 CM 2-BEAD DISPENSER KIT (LINELAZER IV/V 250)	
277065		15 CM 1-BEAD DISPENSER KIT (LINELAZER ES 1000/2000, IV/V 3900/5900/130/200) INCLUDES: BEAD DISPENSER, WIND DEFLECTOR, HOSE AND HOPPER, WITH BRACKETS	
24M641		15 CM 1-BEAD DISPENSER KIT (LINELAZER IV/V 250)	
24Z726		15 CM 1-BEAD DISPENSER KIT (LINELAZER ES 500, 3400)	
277067		15 CM 1-BEAD REPLACEMENT KIT (LINELAZER IV/V, ES 500/1000/2000, 3400) INCLUDES: BEAD DISPENSER, WIND DEFLECTOR AND HOSE	
24N267		30 CM 2-BEAD DISPENSER KIT (LINELAZER IV/V 250)	
24N265		30 CM 1-BEAD DISPENSER KIT (LINELAZER ES 1000/2000, IV/V 3900/5900/130/200)	
24Z727		30 CM 1-BEAD DISPENSER KIT (LINELAZER ES 500, 3400)	
245516		30 CM 1-BEAD REPLACEMENT KIT (LINELAZER IV/V, ES 1000/2000)	
277066		15 CM EZ BEAD WIND DEFLECTOR KIT (6X)	
245520		30 CM EZ BEAD WIND DEFLECTOR KIT (3X)	

LineLazer™ Accessories

PART NUMBER **DESCRIPTION**

WHEEL REPLACEMENTS



113479	FRONT WHEEL REPLACEMENT, PNEUMATIC (LINELAZER IV/V 250)
16W284	FRONT WHEEL REPLACEMENT, FOAM FILLED (LINELAZER IV/V 250)
17R436	3-WHEEL FRONT WHEEL CONVERSION KIT (LINELAZER IV//V 250sps/250dc/250mma 98:2)
245340	WHEEL KIT (LINELAZER IV/V 250, LINEDRIVER) INCLUDES: 1 WHEEL
249082	WHEEL KIT (LINELAZER IV/V 130/3900/5900/200, NOT IV AUTO-LAYOUT) INCLUDES: 2 WHEELS

EXTRA ACCESSORIES

20A163	DEWALT® FLEXVOLT 18V/54V MAX 6 AH LITHIUM-ION BATTERY
20A757	DEWALT® FLEXVOLT 18V/54V MAX 9 AH LITHIUM-ION BATTERY
20A166*	DEWALT® FAN-COOLED FAST CHARGER
25U672	2ND LITHIUM BATTERY KIT, WITH CABLES (LINELAZER ES)
25U601	LITHIUM BATTERY, WITHOUT CABLES (LINELAZER ES)
24X370	BATTERY, WITHOUT CABLES (LINELAZER V HP AUTOMATIC 3900/5900/200)
115753	BATTERY, WITHOUT CABLES (LINELAZER 250)
25U767	BATTERY CONVERSION KIT, AGM TO LITHIUM BATTERY (LINELAZER ES 1000 BEFORE 2022)
25U768	BATTERY CONVERSION KIT, AGM TO LITHIUM BATTERIES (LINELAZER ES 2000 BEFORE 2022)
25A526	BATTERY CONVERSION KIT, WITH BATTERY/CHARGER KIT (LINELAZER V STANDARD 3900/5900/200)
25N711	HP AUTO CONVERSION KIT, STANDARD TO HP AUTO (LINELAZER V ES 2000)
25N790	HP AUTO CONVERSION KIT, STANDARD TO HP AUTO (LINELAZER V STANDARD 3900/5900/200 ALL SERIES)
287626	50 CM STRIPING RAMP, WITH 2 HEADS
25N787	LINEDRIVER HITCH KIT (LINELAZER ES/130/200/3900/5900)
16P015	SAFETY CONE HOLDER
24N600	SAFETY CONE HOLDER, WITH SUPPORT BRACKET
17R472	LED LIGHT KIT (LINELAZER ES)
17R473	LED LIGHT KIT (LINELAZER V HP AUTO 3900/5900/200)
24M598	LED LIGHT KIT (LINELAZER IV/V 250)
249081	ADJUSTABLE, PLASTIC SPRAY SHIELD KIT (LINELAZER)
17K356	2 ND PUMP KIT LL V 250sps INCLUDES: COMPLETE PUMP KIT, HARDWARE, HOSES AND DUAL HOPPER SYSTEM
25N653	FRONT WEIGHT KIT (LINELAZER V 3900/5900/130hs/200hs/200dc/200mma 1:1)



* The EURO-UK converter plug 124507 needs to be ordered separately.

LineLazer™ Accessories

PART NUMBER	DESCRIPTION
MAINTENANCE FLUIDS	
238049	TSL BOTTLE 118 ML
206994	TSL BOTTLE 250 ML
206995	TSL BOTTLE 1 L
206997	TSL BOTTLE 1 L (12X)
206996	TSL BOTTLE 3.8 L
206998	TSL BOTTLE 3.8 L (4X)
253574	PUMP ARMOR 1 L
245133	PUMP ARMOR 3.8 L
207428	HYDRAULIC FLUID 3.8 L
169236	HYDRAULIC FLUID 20 L



LineDriver™ Accessories

LINEDRIVER

PART NUMBER	DESCRIPTION
245321	LINEDRIVER HITCH KIT** (GRINDLAZER HP DC89 G/1013 G (DCS)/DC1021 G (DCS))
25N787	LINEDRIVER HITCH KIT** (LINELAZER ES/130/200/3900/5900)
25R505	LINEDRIVER HITCH KIT** (THERMOLAZER 300TC/PROMELT)
116913	HITCH KIT BALL (LINELAZER V GENERATION)
245340	WHEEL KIT (LINEDRIVER 160) INCLUDES: 1 WHEEL
249083	WHEEL KIT (LINEDRIVER HD/ES) INCLUDES: 2 WHEELS
245343	AUXILIARY BATTERY KIT (LINEDRIVER 160/HD 200)
25U769	BATTERY CONVERSION KIT, AGM TO LITHIUM BATTERIES (LINEDRIVER ES BEFORE 2022)
25U672	2ND LITHIUM BATTERY KIT, WITH CABLES (LINEDRIVER ES)
25U601	LITHIUM BATTERY, WITHOUT CABLES (LINEDRIVER ES)



**Includes ball 116913 and washer 110947

RoadLazer RoadPak™



RoadPak™ and RoadPak™ HD System

Truck Mount Striping Systems



RoadPak HD System



RoadPak 1-Pump System



RoadPak 2-Pump System

► Applications & Materials

RoadPak System, a complete modular setup to comply with your road striping situation. Based upon a RoadPak Module with 1 or 2 pumps, the RoadPak system is delivered in 12 different options or can be compiled to fulfil your striping needs. The RoadPak HD System offers a whole new level with double the output of RoadPak and the ability to stripe with up to 5 paint and 5 bead guns. This is a high-productivity striping machine which is delivered in 4 different options or can be compiled to fulfil your striping needs.

► Features & Benefits Includes all RoadPak System Features PLUS:

Heavy-Duty RPS 2900 Hydraulic System

- Proven performer built off of our highly reliable GH™ 833 then optimized for road striping
- No-stall design provides the productivity you get from Graco designed products
- Maximum pressure of 200 bar

Displacement Pump System

- Graco's displacement pumps have delivered outstanding results in pumping striping paint for over 20 years
- Prime valve allows you to recirculate paint keeping it mixed and ready to go

Heavy-Duty Modular Frame System

- Small frame size allows it to fit almost anywhere – from the back of a pickup or flatbed truck to the bed of a utility vehicle
- Heavy-duty steel frame is built to last
- Simple to add options you want in minutes – optimizing your striping system

Heavy-Duty Compressor

- 6.9 bar at 13.1 cfm
- Accumulation Tank for paint and bead guns (20 liters on RoadPak HD to support up to 5 paint and 5 bead guns)

Kohler® Power

- RoadPak: 19 hp Kohler engine
- RoadPak HD: 26.5 hp EFI Kohler engine
- Over 15 years of reliable experience

1 or 2-Pump RoadPak System

- RoadPak is delivered as a 1-or 2-pump system allowing single or dual colour option (RoadPak HD always 2 pumps)
- Step up to RoadPak HD to double your output up to 37.8 liter per minute
- Optionally expand your system with extra pumps for other colours

RoadView HD Camera System

► RoadView HD Camera System

Turn your RoadPak into a single user vehicle with the RoadView HD Camera System. It allows single users to do the jobs once reserved for the “big trucks” – all from the inside comfort of the striping vehicle.



The camera mounts on the gun arm and travels from one side of the truck to the other without adjustments. The view of the camera allows users to see from behind the paint and bead guns, which is very similar to the view from a walk behind unit. A quick disconnect electrical system for the camera allows safe storing when not using and also allows you to switch between the standard 16 mm or optional 6 mm camera. The 16 mm camera provides a “farther-out” view, while the 6 mm camera option is a great choice for those striping contractors who prefer a “closer-in” view.

It's easy to match up old stripes with the remote, hand activated Switch System. With a push of your thumb, you control the start and stop on those tough restripe jobs.



6 mm Camera

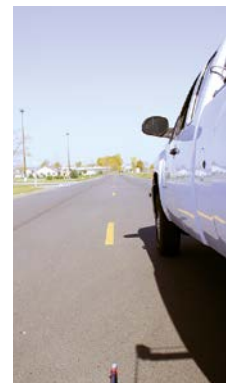

16 mm Camera



► Specifications

- LCD Monitor measurement 9 inch Diagonal: 22.9 cm x 14.5 cm x 3.2 cm
- Ratio: 16:9 Wide TFT Screen
- Camera (16 mm): 6.4 cm x 5 cm x 5 cm
- Power Source: DC 12V
- Operating Temperature: -42°C to 65°C

RoadPak™ Advanced Controller

▶ RoadPak Advanced Controller

The RoadPak Advanced Controller offers an operator simple to use controls that will make striping road jobs easy. Check your Roadpak, program skip lines, measure distances, all from within the comfort of the vehicle.



▶ Pattern Capability

Road Markings

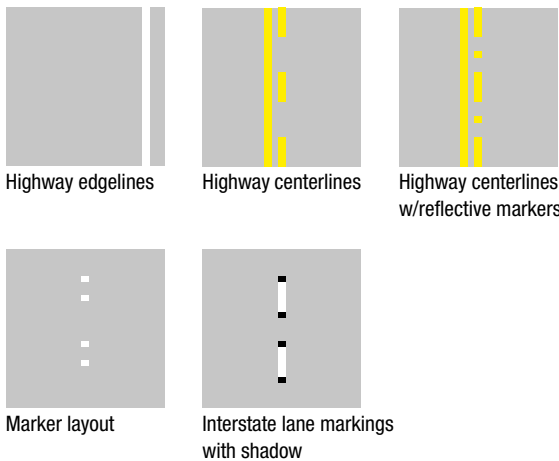

Airport Patterns

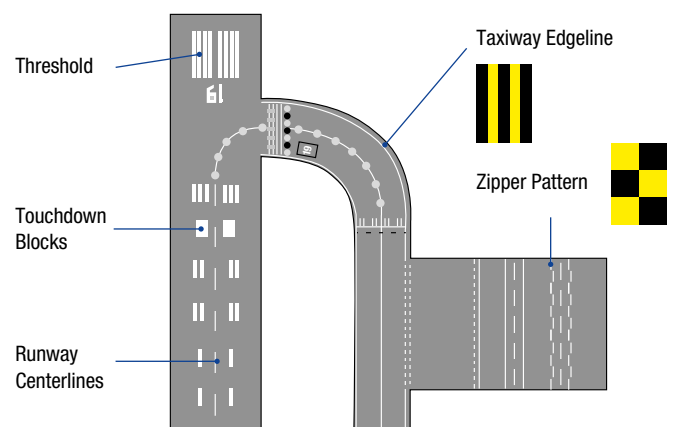

▶ Features

Main screen with pattern preview

- Main screen provides all necessary information while striping
- Pattern preview provides a quick visual of colours and patterns selected

Preset buttons

- User defined preset buttons allow you to adjust the main screen to your personal needs

4-Axis joy-stick

- Easily move through menus and settings and changing or (de)activating parameters

5-Gun toggle control

- Toggle switch for all 5 guns allows for quick activation and control

Proof-of-job

- Included with export capabilities to download jobsite data to USB stick for "proof-of-job"

Pattern ability

- Wide variety of gun activation and pattern capability:
 - > Manual
 - > Automatic
 - > Semi-Automatic
 - > Zipper Pattern
 - > Solid and skip lines
 - > Shadow and Contrast lines

RoadLazer RoadPak™



RoadPak™ Mount System

► RoadPak Mount System

Install your RoadPak on almost any vehicle using a Single-Hitch Mounting Frame or a Slide-In Mounting Frame. The Mounting Frame allows you to attach your gun arm to your vehicle for easy left/right spraying but comes in two easy-to-install options depending on the vehicle on which you want to install your RoadPak.

► Mount Systems

Slide-In Mounting Frame

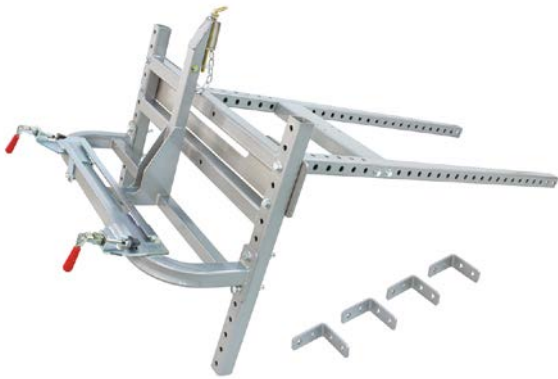

The Slide-in Mounting Frame allows many different vehicles to perform your road striping jobs.

Single-Hitch Mounting Frame



A Single-Hitch Mounting Frame allows you to use your existing vehicle with little or no modifications to carry your gun bar arm with the RoadPak System.

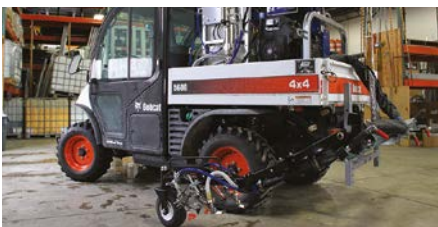

Specifications

ROADPAK

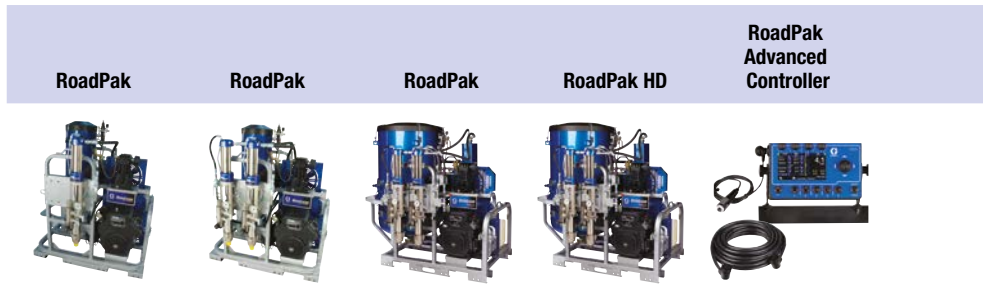

SPECIFICATIONS	RoadPak	RoadPak	RoadPak	RoadPak HD	RoadPak Advanced Controller
Part Number	25M701	25M703	25M704	25M706	25M711
Pumps	1	2	2	2	-
Guns	-	-	-	-	-
Engine - hp	19	19	19	26.5	-
Max. Flow - lpm (gpm)	18.9 (5)	18.9 (5)	18.9 (5)	37.8 (10)	-
Bead Tank - kg (lb)	204 (450)	204 (450)	612 (1350)	612 (1350)	-

ROADPAK SYSTEM READY-TO-STRIPE						
1	RPS – OPTION 1					
		25D268	✓			✓
2	RPS – OPTION 2					
		25D269	✓			✓
3	RPS – OPTION 3					
		25D270	✓			✓
4	RPS – OPTION 4					
		25D271	✓			✓
5	RPS – OPTION 5					
		25D272		✓		✓
6	RPS – OPTION 6					
		25D273		✓		✓
7	RPS – OPTION 7					
		25D274		✓		✓
8	RPS – OPTION 8					
		25D275		✓		✓
9	RPS – OPTION 9					
		25D276			✓	✓
10	RPS – OPTION 10					
		25D277			✓	✓
11	RPS – OPTION 11					
		25D278			✓	✓
12	RPS – OPTION 12					
		25D279			✓	✓
13	RPS – OPTION 13					
		25D280			✓	✓
14	RPS – OPTION 14					
		25D281			✓	✓
12	RPS – OPTION 15					
		25D282			✓	✓
16	RPS – OPTION 16					
		25D283			✓	✓

* The adjustable gun arm beam (24G630) is included by default

RoadPak Gun Arm	RoadPak Gun Arm	RoadPak HD Gun Arm	Slide-in Mounting Frame	RoadView HD Camera System	Simple Guide System	Gun Lift Winch Kit	Rear Seat Kit	Steerable Carriage
-----------------	-----------------	--------------------	-------------------------	---------------------------	---------------------	--------------------	---------------	--------------------



	25M708	25M709	25M710	24G627	24G633	24G634	25M713	25M716	25M712
	1	2	2	-	-	-	-	-	-
	2	2	3	-	-	-	-	-	-
	-	-	-	-	-	-	-	-	-
	-	-	-	-	-	-	-	-	-
	-	-	-	-	-	-	-	-	-

	✓			✓		✓			
	✓			✓	✓	✓			
	✓			✓		✓	✓	✓	✓
	✓			✓	✓	✓	✓	✓	✓
		✓		✓		✓			
		✓		✓	✓	✓			
		✓		✓		✓	✓	✓	✓
		✓		✓	✓	✓	✓	✓	✓
		✓		✓		✓			
		✓		✓	✓	✓			
		✓		✓		✓	✓	✓	✓
		✓		✓	✓	✓	✓	✓	✓
			✓	✓		✓	✓		
			✓	✓	✓	✓	✓		
			✓	✓		✓	✓	✓	✓
			✓	✓	✓	✓	✓	✓	✓

RoadPak™ Accessories

PART NUMBER	DESCRIPTION
-------------	-------------

CHOOSE YOUR ROADPAK MODULE*



25M701	ROADPAK MODULE - 1-PUMP - 18.9 LPM - 204 KG BEAD TANK
25M703	ROADPAK MODULE - 2-PUMP - 18.9 LPM - 204 KG BEAD TANK
25M704	ROADPAK MODULE - 2-PUMP - 18.9 LPM - 612 KG BEAD TANK
25M706	ROADPAK HD MODULE - 2-PUMP - 37.8 LPM - 612 KG BEAD TANK

* See OEM section for modules without bead tanks

CHOOSE YOUR GUN ARM MOUNTING SYSTEM



24G627	SLIDE-IN MOUNTING FRAME
24G626	SINGLE HITCH MOUNTING FRAME





CHOOSE YOUR GUN ARM











25M708	1-PUMP, 2-GUN ROADPAK GUN ARM (2x paint guns, 2x bead guns, all hoses)
25M709	2-PUMP, 2-GUN ROADPAK GUN ARM (2x paint guns, 2x bead guns, all hoses)
25M710	2-PUMP, 3-GUN ROADPAK GUN ARM (3x paint guns, 3x bead guns, all hoses, stabilizing wheel and longer gun mount bar)
25D932	2-PUMP, 3-GUN ROADPAK GUN ARM (3x paint guns, no bead guns, all hoses, stabilizing wheel and longer gun mount bar)
25D642	ROADPAK ADDITIONAL GUN KIT (ROADPAK AS OF 2018) Kit comes with a dual acting paint gun, dual acting bead gun, the hardware and hoses to connect the guns to the system.
24G630	ADJUSTABLE GUN ARM BEAM



RoadPak™ Accessories

PART NUMBER	DESCRIPTION
CHOOSE YOUR ROADPAK MAJOR ASSEMBLY ADD-ONS	
	25M711 ROADPAK ADVANCED CONTROLLER
	24G633 ROADVIEW HD CAMERA SYSTEM
	24G771 6 MM CAMERA KIT Kit includes a 6mm camera. Cable included to connect to monitor (closer in view)
	24H555 16 MM CAMERA KIT Kit includes a 16 mm camera. Cable included to connect to monitor (farther out view)
	24G634 SIMPLE GUIDE SYSTEM
	241880 DYNAMIC FRONT ARTICULATING POINTER Dynamic front articulating pointer. Excellent for those hard-to-stripe curves

CHOOSE YOUR ROADPAK MODULE ACCESSORIES

	25M716 REAR SEAT KIT Seat with safety belt, base mounting plate, bracket for controller
	25M712 STEERABLE CARRIAGE KIT Kit has the steerable carriage controller, gun arm actuator and mounting brackets
	17U930 LAZERGUIDE 3000 Long-Line Laser for RoadPak
	25M713 GUN LIFT/WINCH KIT Kit comes with a winch, the mounting brackets, and the wiring to connect it to a RoadPak system. The winch can easily be moved from one side of the vehicle to the other.
	24G766 RPS 2900 COMPLETE PUMP KIT Kit has an RPS 2900 Pump with all the hydraulic lines and fasteners needed to mount to the RoadPak system.
	25D643 PRESSURE BALANCE KIT To balance pressure between two pumps pumping same colour. Provides the same pressure to each gun.
	24G769 125 LITER ROTOMOLD PAINT TANK Kit includes a 125 liter paint tank, mounting brackets and fasteners. It can be mounted onto the RoadPak frame or the accessory frame kit.
	239934 PAINT TRANSFER KIT Kit used to transfer paint from one location to another. Air-driven, double-diaphragm Husky™ pump powered by the RoadPak. Includes all hoses, fittings, 208 liter drum and siphon kit.

RoadPak™ Accessories

**PART
NUMBER** **DESCRIPTION**

CHOOSE YOUR ROADPAK MODULE ACCESSORIES (continued)

239935	<p>PAINT DRUM AGITATOR KIT Kit used to mix paint in a 208 liter drum. All SST construction air-driven Twistork™ motor powered by the RoadPak air system.</p>
24J149	<p>BOTTOM FEED FITTINGS KIT (FOR PAINT TANK) Kit allows user to drill a hole in the bottom of the 125 liter paint tank and connect fittings so the material can flow out the bottom of the tank rather than being sucked out the top.</p>
24G774	<p>ROADPAK Y-STRAINER KIT Kit is a Y-strainer that connects inline between the paint drum and the pump inlet.</p>
24G765	<p>ROADPAK 205 KG BEAD TANK KIT Kit has a bead tank with regulator, mounting brackets and fasteners. It can be mounted onto the RoadPak frame or the accessory frame kit</p>
25D608	<p>ROADPAK 615 KG BEAD TANK KIT WITH FRAME Kit has a 615 kg bead tank installed in an accessory frame</p>
25D641	<p>ROADPAK 615 KG BEAD TANK Kit has a 615 kg bead tank with regulator, mounting brackets and fasteners</p>
24G772	<p>ROADPAK 3RD GUN KIT (ROADPAK BEFORE 2018) Kit comes with a dual acting paint gun, dual acting bead gun, the hardware and hoses to connect the guns to the system</p>
24G775	<p>ROADPAK DOUBLE DROP KIT Kit is for element double drop application. It comes with one bead gun, one bead hose and fittings to connect the parts</p>
24G776	<p>WATERBORNE SIPHON KIT (ROADPAK ONLY) Suction hose for waterborne materials</p>
24G777	<p>SOLVENT SIPHON KIT (ROADPAK ONLY) Suction hose for oil-based materials</p>
24G979	<p>BEAD GUN KIT Kit for a single bead gun</p>
24G980	<p>PAINT GUN KIT Kit for a single paint gun</p>
24G778	<p>ROADPAK STENCIL GUN KIT</p>
238957	<p>HAND BEAD GUN KIT</p>
24H585	<p>ROADPAK ACCESSORY FRAME KIT Accessory frame that includes the hardware to connect it to the RoadPak frame</p>





► THERMOPLASTIC APPLICATIONS





ThermoLazer™

FEATURES

UNITS

ThermoLazer 200tc
ThermoLazer 300tc
ThermoLazer ProMelt

SPECIFICATIONS

ACCESSORIES

ThermoLazer™ Kettle Systems

A kettle system for your needs. That's what we strive for. High volume ThermoLazers with external refills or built-in heaters or a medium volume ThermoLazer with easy kettle exchange for colour changes, Graco offers it all.



▶ ThermoLazer 200tc Exchangeable Kettle System

Easy exchange of the kettle system allows fast colour changes. Use multiple colours on the same machine by exchanging kettles on the jobsite. No more hassle with multiple dedicated units.



▶ ThermoLazer 300tc Dual PaddleMax™ System

Reduce the need to constantly refill with a 135kg single chamber hopper. The single chamber design allows easy refills from an external kettle system and the Dual Paddles make mixing materials easy.



▶ ThermoLazer ProMelt QuadMelt™ System

Stepping up to the ProMelt QuadMelt system offers you four on-board chambers that can melt 135 kg of material in less than 1 hour, significantly increasing your daily productivity. The four chamber design offers more surface area to quickly melt thermoplastic and is supported by 100,000 BTU burners which increases melt time and productivity.

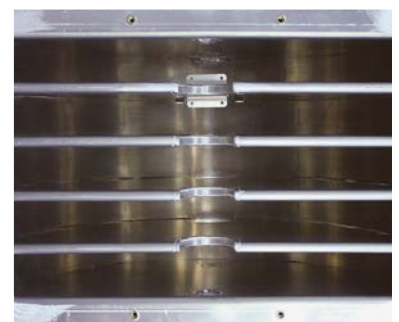

ThermoLazer™ Die Systems

From narrow over wide to double lines, choose the Die-System for your ThermoLazer: SmartDie II for ThermoLazer 300tc and ProMelt or FlexDie for ThermoLazer 200tc. These hardened steel dies come with an innovative, built-in line thickness adjustment system that allow you to easily dial down to the desired depth. Our Die Systems come in a variety of sizes allowing you to do narrow or wide lines or win time and money with our Double Line Systems.



► Line Types

Narrow Lines



Wide Lines



Double Lines



► Features



Line Thickness Adjustment

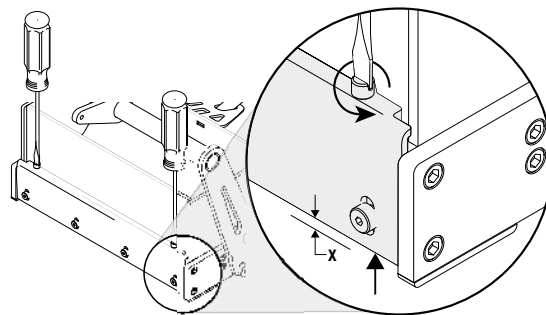

X ↑	↻ #Turns
30	0.6
60	1.2
90	1.8
120	2.4
150	3.0
mm	#Turns
0.5	0.4
1.0	0.8
1.5	1.2
2.0	1.6

BlackDie™ surface for maximum heat retention



Handle bar for easy die replacement and disassembly without tools

ThermoLazer™ Units



ThermoLazer™ 200tc



ThermoLazer 200tc



► Applications & Materials

The ThermoLazer System, brought to you by Graco is one of the most productive and easy to use thermoplastic handliners in the industry. The ThermoLazer 200tc is an ideal unit to expand your thermo fleet with a small push-behind unit for those small jobs.

► Features & Benefits

FlexDie™ System

- Delivers excellent line quality with exclusive deep-die, all steel construction and a no-tools change-out design

90 kg Material Kettle

- Easy-to-fill cylindrical kettle allows precise melting of thermoplastic material, and its no-tool change-out design lets you switch colours fast

18 kg Bead Hopper

- Perfectly matched to the material kettle with a superior flow design

Direct Heat System

- Direct flames and an on-board hand torch deliver maximum heat, resulting in maximum material flow

Tri-Wheel System

- Dual solid front and single solid rear wheels provide smooth, quiet operation

Adjustable Handle

- Handle easily adjusts to multiple heights

Adjustable Front Pointer

- Easily adjusts for all size dies for following all marks and creating straight lines

Bead Dispenser

- 30 cm dispenser with 2.5 cm increments allows you to "dial-in" the drop rate

ThermoLazer™ 300tc



ThermoLazer 300tc



► Applications & Materials

The ThermoLazer 300tc with its 135 kg material kettle allows more striping and less time spent refilling with material, while its' EasyGlide™ Wheel Mount System makes this unit as easy to maneuver as a LineLazer.

► Features & Benefits

SmartDie II System

- Delivers excellent line quality with exclusive deep-die, all steel construction and a no-tools change out design

135 kg Material Kettle

- Easy-to-fill kettle with PaddleMax Dual mixer for improved mixing

40 kg Bead Hopper

- Perfectly matched to the material kettle with a superior flow design

Direct Heat System

- Direct flames and an on-board hand torch deliver maximum heat, resulting in maximum material flow

Adjustable Handle

- Handle easily adjusts to multiple heights

Adjustable Front Pointer

- Easily adjusts for all size dies for following all marks and creating straight lines

Bead Dispenser

- 30 cm dispenser with 2,5 cm increments allows you to "dial-in" the drop rate

ThermoLazer™ ProMelt



ThermoLazer ProMelt



LineDriver

► Applications & Materials

Only Graco's breakthrough technology allows you to melt 135 kg of thermoplastic on-board in less than an hour. It's like having a premelter on wheels without the cost. Finally a solution for melting and applying thermoplastic without the hassle and cost of premelters.

► Features & Benefits

ProMelt Technology

- 4 Chamber Melting System - More surface area to melt thermoplastic fast
- 100,000 BTUs - Faster melt time means more jobs get done everyday

SmartDie II System

- Delivers excellent line quality with exclusive deep-die, all steel construction and a no-tools change-out design

135 kg Material Kettle

- Easy-to-fill four chamber Quadmelt kettle system for improved heat transfer and mixing

40 kg Bead Hopper

- Perfectly matched to the material kettle with a superior flow design

Adjustable Handle

- Handle easily adjusts to multiple heights

Adjustable Front Pointer

- Easily adjusts for all size dies for following all marks and creating straight lines

Bead Dispenser

- 30 cm dispenser with 2,5 cm increments allows you to "dial-in" the drop rate

Specifications

UNITS

ThermoLazer 200tc



ThermoLazer 300tc



ThermoLazer ProMelt



SPECIFICATIONS			
Part Number - unit only	24U281	24H622	24H624
Fuel	LP gas (LP tank not included)	LP gas (LP tank not included)	LP gas (LP tank not included)
Die Heater system	-	Tri-Flame	Tri-Flame
Main Burners	30.000 BTU	30.000 BTU	100.000 BTU
Material Capacity – kg (lbs)	90 (200)	135 (300)	135 (300)
Melt Time (135 kg without premelter)	Up to 2,5 hours	Up to 4,5 hours	1 - 1,5 hours max.
Melt chamber	Single	Single	QuadMelt
Bead Hopper Capacity – kg (lbs)	18 (40)	40 (90)	40 (90)
Weight – kg (lbs)	118 (260)	133 (295)	157 (345)
FEATURES			
Dies available	FlexDie	SmartDie II	SmartDie II
Temperature Limit Control	N/A	N/A	475° F Switch
Electronic Ignition	No	✓	✓
Torch	✓	✓	✓
External 4-torch die heat system	Burners on FlexDie	Optional	Standard
Internal Mixing Paddles	Single mixing paddle	Dual PaddleMax System	QuadMix System
Hopper Lid System	Flat, Single Lid	Flat, Dual Lid	Raised, Single Lid
Bead Dispense System	30 cm with 2.5 cm doors	30 cm with 2.5 cm doors	30 cm with 2.5 cm doors
LineDriver Compatible*	No	Optional	Optional

► Applications

Model	Project size			Applications				
	Small <135 kg (<300 lbs)	Medium 135-405 kg (300-900 lbs)	Large >405 kg (>900 lbs)	Stencils	Intersections	Parking lots	Bike paths	Roads
ThermoLazer 200tc		Premelter required						
ThermoLazer 300tc		Premelter required				LineDriver Recommended		
ThermoLazer ProMelt			Premelter required			LineDriver Recommended		

Best choice
 Better choice
 Suitable choice

* See page 22-23 and 55 for more information on all LineDriver units.

THERMOLAZER™ ACCESSORIES

PART NUMBER	DESCRIPTION
24R144	BEAD DISPENSER KIT (30 CM WITH 2.5 CM SLOTS)
257368	SCREEN, FILTER
24C528	KIT, DOUBLE DROP DISPENSER (THERMOLAZER 300TC/PROMELT)
24J179	SCRAPER KIT, LONG HANDLE (FOR CLEANING PROMELT KETTLE)
24J356	SCRAPER BLADES (5-PACK)
24H619	REAR BURNER KIT 4-TORCH (THERMOLAZER 300TC/PROMELT)
25R505	LINEDRIVER HITCH KIT (THERMOLAZER 300TC/PROMELT)
17B190	40 CM BEAD DISPENSER (FOR DIES LARGER THAN 30 CM)
16Y835	EXTRA KETTLE FOR THERMOLAZER 200tc (ADDING EXTRA COLOUR)



PART NUMBER	SIZE CM (IN)
THERMOLAZER 300tc + THERMOLAZER PROMELT	

SMARTDIE

SINGLE LINE SMARTDIE	PART NUMBER	SIZE CM (IN)
	17A173	5 (2)
	24H431	8 (3)
	24H426	10 (4)
	17J250	12 (4.75)
	24H432	13 (5)
	24H427	15 (6)
	24H433	18 (7)
	24H428	20 (8)
	24H434	22.5 (9)
	24H429	25 (10)
	24H430	30 (12)
	17A174	40 (16)



DOUBLE LINE SMARTDIE	PART NUMBER	SIZE CM (IN)
	24H437	8-8-8 (3-3-3)
	24H435	10-8-10 (4-3-4)
	24H436	10-10-10 (4-4-4)
	24J785	10-15-10 (4-6-4)
	17R378	13-13-13 (5-5-5)

PART NUMBER	SIZE CM (IN)
THERMOLAZER 200tc	

FLEXDIE

SINGLE LINE FLEXDIE	PART NUMBER	SIZE CM (IN)
	16Y661	5 (2)
	16Y662	8 (3)
	16Y320	10 (4)
	16Y663	12 (4.75)
	16Y190	15 (6)
	16Y664	18 (7)
	16Y326	20 (8)
	16Y665	22.5 (9)
	16Y332	25 (10)
	16Y207	30 (12)

DOUBLE LINE FLEXDIE	PART NUMBER	SIZE CM (IN)
	16Y338	8-8-8 (3-3-3)
	16Y352	10-8-10 (4-3-4)
	16Y363	10-10-10 (4-4-4)

▶ TAPE APPLICATIONS





TapeLazer™

FEATURES

UNITS

TapeLazer HP

SPECIFICATIONS

ACCESSORIES

TapeLazer HP Automatic



TapeLazer™ HP with LineDriver HD 200

► **Flexible & safe operation**

Adjustable carriage

- Slide the tape carriage right or left to get within 8 cm of the road edge
- Keeps you safe and out of traffic
- Single wrench needed for service



► **Debris-free design**

Dual swivel wheels

- Exclusive design keeps the front tires and debris out of the primer resulting in better adhesion



► **Fast, accurate tape loading**

EZ Load tape system

- Toolless locator collars for quick/easy change-out
- EasyMark tape bar and guide rollers allow for quick and easy tape alignment resulting in straighter lines



QUICKCHANGE BLADE REPLACEMENT

SWAP OUT THE BLADE IN SECONDS –
KEEPS YOU UP AND RUNNING ON THE JOB!



1 Remove screw



2 Swap out blade



3 Reinstall screw

TapeLazer HP Automatic



► **Flexible, non-stick application**

Ultra-flex rollers

- Non-stick, ultra-flex rollers eliminate adhesive and primer build-up
- Segmented design allows roller width to match tape width for optimal performance, even on inlay applications



1 Remove screws



2 Take out roller assembly



3 Remove roller(s)



4 Set roller(s) in place



5 Reinstall the roller assembly



TapeLazer™ HP Automatic

Walk-behind taper



LiveLook display and adjustable carriage.

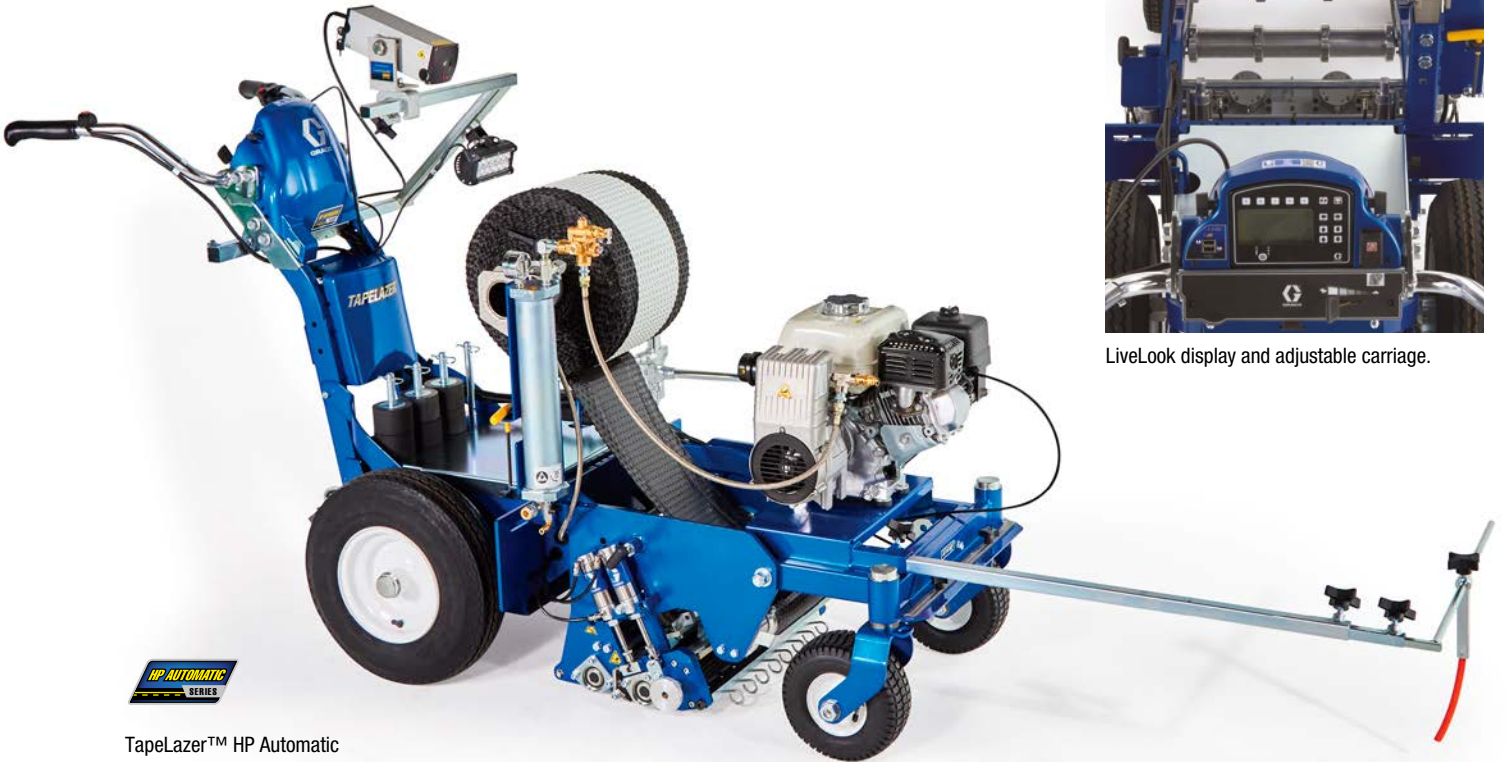

TapeLazer™ HP Automatic
(unit shown includes optional LazerGuide 3000 and high-output LED light)

► Applications & Materials

Apply permanent or temporary tape automatically with the accuracy of a walk-behind taper and the comfort and productivity of a large taper truck. The TapeLazer™ HP Automatic makes tape line marking user-friendly and cost effective. Add a LineDriver to maximize productivity and to reduce fatigue on every application.

► Features & Benefits

Quality cuts every time

- Exclusive 2-stage cutting process that eliminates “pull up” of tape during cutting ensuring the best possible adhesion
- The Precision-Cut™ system with pneumatic brake stops the tape for an instant while cutting resulting in a crisp, clean cut

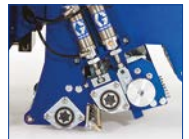

Trouble-free cutting

- Single, no-stick blade cuts on the non-adhesive side of the tape eliminating adhesive buildup and the need for an oiler to maintain
- QuikChange™ blade replacement allows to swap out the blade in seconds and keeps you up and running on the job



Automatic tape application

- Push button control for lower operator fatigue and accurate (skip-)lines
- Manual, semi- and automatic mode
- System delay for accurate starts/stops



Specifications

UNITS - HP AUTOMATIC SERIES



TapeLazer HP Automatic



SPECIFICATIONS	
Part Number	20A024
Max. Tape width – cm (in.)	35.5 (14)
Max Speed – kph (mph)	9.5 (6)
Max. Pressure – bar (PSI)	10 (145)
Motor Rating – cm3	160
Weight – kg (lbs)	232 (512)
FEATURES	
LiveLook Display	✓
Precision-Cut system	✓
QuikChange™ blade replacement	✓
Segmented non-stick rollers	✓
EasyMark™ tape bar and guide rollers	✓
Adjustable tape carriage	✓
Dual swivel wheels	✓
LineDriver*	Optional (recommended)
COMPOSITION	
Guide bar	✓
Single, no-stick blade	✓ (2x)
T-Handle hex key Allen wrench	✓
Full segmented rollers	✓

* See page 22-23 and 51 for more information on all LineDriver units.

ACCESSORIES

	PART NUMBER	DESCRIPTION
	20A484	QUIKCHANGE BLADE
	20A485	ULTRA-FLEX TAMPING ROLLER ASSEMBLY
	20A486	ULTRA-FLEX APPLICATOR ROLLER ASSEMBLY
	20A487	ULTRA-FLEX ROLLER (SINGLE ROLLER)
	20A488	PRECISION-CUT BRAKE ASSEMBLY
	17V405	LAZERGUIDE 3000 LONG-LINE LAZER
	17R473	HIGH-OUTPUT LED LIGHT

▶ PARTS





OEM PARTS

TIPS & NOZZLES

HOSES

SWIVELS, ADAPTERS & NIPPLES

REPAIR PARTS

OEM Pumps and Guns



OEM Pumps and Guns

PUMPS



PART NUMBER	DESCRIPTION	BEAD TANK (KG)	FLOW (LPM)	MAX. PRESSURE (BAR)
25M701	ROADPAK 1-PUMP MODULE	204	18.9	200
25M702	ROADPAK 1-PUMP MODULE, OEM	NO BEAD TANK	18.9	200
25M703	ROADPAK 2-PUMP MODULE	204	18.9	200
25M704	ROADPAK 2-PUMP MODULE	612	18.9	200
25M705	ROADPAK 2-PUMP MODULE, OEM	NO BEAD TANK	18.9	200
25M706	ROADPAK HD 2-PUMP MODULE	612	37.8	200
25M707	ROADPAK HD 2-PUMP MODULE, OEM	NO BEAD TANK	37.8	200
24G767	GH 2950 OEM KIT		18.9	275
24U325	GH2570 OEM KIT		26.5	172
25U989	ROADLAZER™ HPS 135, SEVERE DUTY™		51	172
25U813	ROADLAZER™ HPS 135, MAXLIFE™		51	172
25U809	ROADLAZER™ HPS 180, SEVERE DUTY™		68	138
25U814	ROADLAZER™ HPS 180, MAXLIFE™		68	138
24J345	LL 130hs PUMP KIT		4.9	227
24B932	LL 200hs PUMP KIT		8.14	250
16T532	LL 250 PUMP KIT		9.5	227
24W299	GH 300 PUMP KIT		11.3	227
24W298	GH 200 PUMP KIT		8.1	227
238349	VISCOUNT PUMP, ROADLAZER		9.5	138

GUNS



238377	AUTOMATIC PAINT GUN			
24G980	AUTOMATIC PAINT GUN DOUBLE ACTING			
238338	AUTOMATIC BEAD GUN			
24G979	AUTOMATIC BEAD GUN DOUBLE ACTING			
248157	FLEXPLUS STRIPING GUN, RAC V GUARD, LL5319 TIP			
235460	SILVER GUN, 2-FINGER, FLAT TIP GUARD, NO TIP			

LL5 Spray Tips: Creating Laser-Sharp Lines

► Graco's LineLazer RAC V SwitchTips

Specially designed for Line Striping Equipment, Graco's LL5 spray tips create clean and laser-sharp lines with no fuzzy edges. LL5 tips spray heavy waterbase to thin alkyd traffic paint and ensures consistent paint thickness, from edge to edge, less overspray and long-lasting lines.

Understanding Tips

The pump delivers:

- Paint flow
- Paint pressure

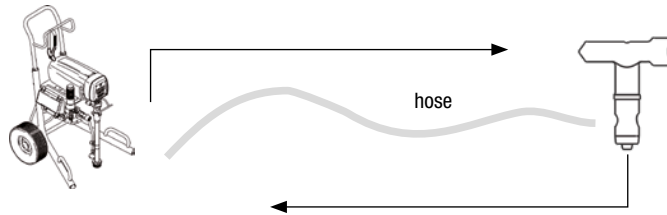

The tip defines:

- Spray angle
- Spray volume

The tip size tells the pump how hard it must work.

The Secret behind the Numbers

(All tip specifications are measured 30 cm away from the surface)



The first digit describes the angle, i.e. 6 = 60°.

Multiply first digit by 5 to get the actual fan width when spraying 30 cm away from the wall, i.e. $6 \times 5 = 30$ cm.

The 2nd and 3rd digits describe the orifice size, i.e. 21 = 0.021".

Adjusting to the Right Tip

Basic rule: when switching tips, adjust to the new fan width and new orifice size. Together. e.g.: 517 -> 619

PROBLEM	SOLUTIONS
<p>Too much paint?</p> <p>0.017" = 1.17 lpm</p>	<p>1. Reduce orifice size</p> <p>513</p> <p>0.013" = 0.7 lpm</p> <p>2. Increase fan angle</p> <p>717</p>
<p>Not enough paint?</p> <p>0.017" = 1.17 lpm</p>	<p>1. Increase orifice size</p> <p>521</p> <p>0.021" = 1.8 lpm</p> <p>2. Decrease fan angle</p> <p>317</p>

LL5 Spray Tips

When to replace a Tip?

A spray tip controls the amount of fluid sprayed by using different orifice sizes. The shape of the orifice on the other hand, determines the spray pattern. The chart below explains the impact of tip wear on the quality of your job.

WHAT IS TIP WEAR?

- 1) **FAN WIDTH DECREASES** = MORE PASSES NECESSARY = MORE LABOUR
 +
 2) **ORIFICE SIZE INCREASES** = MORE PAINT COMES OUT = MORE MATERIAL COST
 ———
TOTAL: TWICE THE LABOUR! + 30% MORE PAINT FOR THE SAME SURFACE!

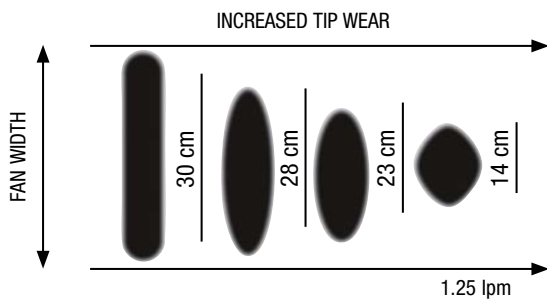

TIP WEAR CHART:

FAN WIDTH - NEW TIP	FAN WIDTH - WHEN WORN
5 cm	4 cm
10 cm	8 cm
15 cm	12 cm
20 cm	15 cm
25 cm	20 cm
30 cm	25 cm
35 cm	30 cm
40 cm	35 cm
45 cm	40 cm

* These are recommendations only.

* Paint abrasion and pressure are the two variables increasing wear speed.

Spray Tips

LL5XXX



ORIFICE	FLOW LPM	FAN WIDTH			
		5 cm	10 cm	15 cm	30 cm
.013	.69	213	-	-	-
.015	.91	215	315	-	-
.017	1.17	217	317	417	-
.019	1.47	219	319	419	-
.021	1.79	-	321	421	621
.023	2.15	-	323	423	623
.025	2.54	-	325	425	625
.027	2.96	-	327	427	627
.029	3.42	-	329	429	629
.031	3.90	-	331	431	631
.033	4.42	-	333	-	-
.035	4.98	-	335	435	635
.039	6.18	-	339	439	639
.043	7.51	-	343	443	643
.055	12.29	-	355	-	-

**PART
NUMBER** **DESCRIPTION**

GUARDS



243161 RAC V GUARD

Spray Tips

262XXX



ORIFICE	FLOW LPM	FAN WIDTH								
		5 cm	10 cm	15 cm	20 cm	25 cm	30 cm	35 cm	40 cm	50 cm
.007	.2	-	207	307	-	-	-	-	-	-
.009	.3	109	209	309	409	509	609	-	-	-
.011	.5	111	211	311	411	511	611	-	-	-
.013	.69	113	213	313	413	513	613	-	-	-
.015	.91	115	215	315	415	515	615	-	815	-
.017	1.17	-	217	317	417	517	617	-	817	917
.019	1.47	119	219	319	419	519	619	-	819	-
.021	1.79	121	221	321	421	521	621	721	821	-
.023	2.15	-	223	323	423	523	623	723	-	-
.025	2.54	-	225	325	425	525	625	725	-	-
.027	2.96	-	-	327	427	527	627	-	827	-
.029	3.42	-	-	-	429	529	629	729	-	-
.031	3.90	-	-	331	431	531	631	-	831	-
.033	4.42	-	-	-	433	533	633	-	833	-
.035	4.98	-	235	-	435	535	635	735	835	935
.039	5.86	-	-	-	439	-	-	-	-	-
.043	6.45	-	-	-	443	543	-	-	-	-
.045	7.5	-	-	-	-	-	645	-	-	-
.051	10.5	-	-	-	451	551	-	-	-	-
.055	12.3	-	-	-	455	555	655	-	-	-
.063	16.3	-	-	-	-	563	-	-	-	-

Spray Tips

163XXX



ORIFICE	FLOW LPM	FAN WIDTH								
		5 cm	10 cm	15 cm	20 cm	25 cm	30 cm	35 cm	40 cm	45 cm
.07	.20	107	207	307	-	-	-	-	-	-
.09	.33	109	209	309	409	509	609	-	-	-
.111	.49	111	211	311	411	511	611	711	-	-
.13	.69	113	213	313	413	513	613	713	813	-
.15	.91	115	215	315	415	515	615	715	815	915
.17	1.17	117	217	317	417	517	617	717	817	917
.19	1.47	119	219	319	419	519	619	719	819	919
.21	1.79	121	221	321	421	521	621	721	821	921
.23	2.15	-	223	323	423	523	623	723	823	923
.25	2.54	-	225	325	425	525	625	725	825	925
.27	2.96	-	227	327	427	527	627	727	827	927
.29	3.42	-	-	329	429	529	629	729	829	929
.31	3.90	-	231	331	431	531	631	731	831	931
.33	4.42	-	-	-	433	-	633	733	833	933
.35	4.98	-	235	335	435	535	635	735	835	935
.37	5.56	-	-	-	-	-	637	737	-	-
.39	6.18	-	239	339	439	539	639	-	839	939
.41	6.83	-	-	341	441	541	641	-	841	-
.43	7.51	-	-	-	443	543	643	-	-	943
.45	8.23	-	-	-	445	545	645	-	845	-
.47	8.98	-	-	-	-	547	647	-	847	-
.49	9.76	-	-	-	449	-	-	749	849	-
.51	10.67	-	-	351	451	551	651	-	-	-
.55	12.29	-	-	-	455	555	655	-	-	-
.57	13.20	-	-	357	457	557	657	757	-	-
.59	14.14	-	-	-	459	-	-	-	-	-
.61	15.12	-	-	-	461	561	661	-	861	-
.63	16.13	-	-	-	463	563	663	-	-	-
.65	17.17	-	-	-	465	565	665	-	865	-
.67	18.24	-	-	-	-	-	667	-	-	-
.71	20.48	-	-	-	471	-	671	-	871	-
.77	24.00	-	-	-	477	-	-	-	-	-

PART NUMBER **DESCRIPTION**

GUARDS



220251 FLAT TIP GUARD

Hoses

PART NUMBER	DESCRIPTION	FITTINGS
BLUEMAX™ II		
227 bar (3300 psi)		
82°C Temperature Rating		
238358	3/16 in x 0.9 m	1/4" NPS(f) – 1/4" NPT(m)
238959	3/16 in x 1.4 m	1/4" NPS(f) – 1/4" NPT(m)
238359	3/16 in x 1.8 m	1/4" NPS(f) – 1/4" NPT(m)
214981	3/16 in x 4.6 m	1/4" NPS(f)
214698	3/16 in x 7.5 m	1/4" NPS(f)
214697	3/16 in x 15 m	1/4" NPS(f)
223756	1/4 in x 4.6 m	1/4" NPS(f)
240793	1/4 in x 7.5 m	1/4" NPS(f)
240794	1/4 in x 15 m	1/4" NPS(f)
223771	1/4 in x 30 m	1/4" NPS(f)
240796	3/8 in x 7.5 m	3/8" NPS(f)
240797	3/8 in x 15 m	3/8" NPS(f)
241275	3/8 in x 30 m	3/8" NPS(f)
BLUEMAX II HP		
276 bar (4000 psi)		
82°C Temperature Rating		
277249	1/4 in x 0.9 m	1/4" NPS(f) – 3/8" NPT(m)
277250	1/4 in x 15 m	1/4" NPS(f)
277351	3/8 in x 0.9 m	3/8" NPS(f) – 1/2" NPT(m)
277251	3/8 in x 15 m	3/8" NPS(f)
277253	1/2 in x 15 m	1/2" NPT(f)
XTREME DUTY HIGH PRESSURE AIRLESS HOSE		
310 bar (4500 psi)		
H42503	1/4 in x 0.9 m	1/4" NPS(f)
H42506	1/4 in x 1.8 m	1/4" NPS(f)
H42510	1/4 in x 3 m	1/4" NPS(f)
H42525	1/4 in x 7.5 m	1/4" NPS(f)
H42550	1/4 in x 15 m	1/4" NPS(f)
H4251X	1/4 in x 30 m	1/4" NPS(f)
H43803	3/8 in x 0.9 m	3/8" NPS(f)
H43806	3/8 in x 1.8 m	3/8" NPS(f)
H43810	3/8 in x 3 m	3/8" NPS(f)

Swivels, Adapters & Nipples

PART NUMBER	DESCRIPTION	MAX. WORKING PRESSURE – BAR	SEAL MATERIAL	SWIVEL MATERIAL
GUN SWIVELS				
M X F STRAIGHT SWIVEL UNION				
244515	1/4" NPT(M) x 1/4" NPSM(F)	210	LEATHER	CS
223341	1/4" NPT(M) x 1/4" NPSM(F)	250	PTFE	CS
239663	1/4" NPT(M) x 1/4" NPSM(F)	250	LEATHER	CS
207947	1/2" NPT(M) x 1/2" NPT(F)	410		CS ZINK PLATED

SWIVEL UNIONS

M X F STRAIGHT SWIVEL UNION

156823	1/4" NPT(M) x 1/4" NPT(F)	690		CS
157705	1/4" NPT(M) x 3/8" NPSM(F)	515		CS
190451	1/2" NPT(M) x 1/2" NPSM(F)	206		CS

F X F STRAIGHT SWIVEL UNION

159153	1/4" NPT(F) x 3/8" NPT(F)	515		CS
156173	3/8" NPSM(F) x 1/4" NPT(F)	510		CS
161077	1/2" NPT(F) x 3/8" NPSM(F)	240		CS
155865	1/2" NPSM(F) x 1/2" NPT(F)	500		CS

HEX NIPPLE

M X M STRAIGHT NIPPLE

162453	1/4" NPSM(F) x 1/4" NPT NPSM	515		CS
156971	1/4" NPT x 1/4" NPT	515		CS
156849	3/8" NPT x 3/8" NPT	500		CS
196178	3/8" NPSM x 3/8" NPT	350		CS WITH E-NICKEL
157350	3/8" NPT x 1/4" NPT	413		CS
158491	1/2" NPT x 1/2" NPT	510		CS

Swivels, Adapters & Nipples

PART NUMBER	DESCRIPTION	MAX. WORKING PRESSURE – BAR	SEAL MATERIAL	SWIVEL MATERIAL
REDUCING NIPPLES				
M X M				
191872	1/8" NPT x 1/4" NPSM	345		CS
165274	1/4" NPT x 11/16" - 27 UNS	345		CS
164856	3/8" NPT x 1/4" NPT	550		SS
164672	3/8" NPT x 1/4" NPSM	413		CS
196177	3/8" NPT x 1/4" NPSM	415		CS WITH E-NICKEL
161800	3/4" NPT x 3/8" NPSM	275		CS
196142	3/4" NPT x 1/2" NPT	345		CS
158979	1/2" NPT x 3/8" NPT	375		CS WITH E-NICKEL
159239	1/2" NPT x 3/8" NPT	510		CS

ADAPTERS

M X F				
244825	1/4" NPT, 7/8" - 14 UNP	230		CS
104969	1/2" NPT x 3/4" NPT	275		CS
181085	7/8" NPT - 14 UNF, 11/16" NPT - 16 UNEF metric gun to Graco guard	345		CS
181084	7/8" - 14 UNF, 3/4" NPT	345		CS
164120	11/16" - 16 UNEF, 3/4" NPT 7/8" - 14 UNF-2B Graco gun to metric guard	345		CS
159841	1/4" NPT(F) x 3/8" NPT(M)	345		CS

PIPE TEES

F X F X M				
106228	2 X 1/4" NPT(F) x 1/4" NPT(M)	210		BRASS
108673	2 X 3/8" NPT(F) x 3/8" NPT(M)	275		SS
111337	2 X 3/4" NPT(F) x 3/4" NPT(M)	275		CS

BALL VALVES

239280	1/4" NPT(MBE)	350		FLUOELASTOMER
238694	3/8" NPT(MBE)	350		PTFE / SS
223522	1/4" NPT(M) x DRILLED PLUG	350		FLUOELASTOMER
224441	3/8" NPT(M) x DRILLED PLUG	350		FLUOELASTOMER
238967	3/8" NPT(M) (MBE)	350		PTFE WITH PEEK SEAT

Repair Parts

LINELAZER - ROADPAK	QUICK REFERENCE							
	LINELAZER ES 1000	LINELAZER V ES 2000	LINELAZER 3400	LINELAZER V 3900	LINELAZER V 5900	LINELAZER 130HS	LINELAZER V 200HS/DC	
LOWER PUMP KIT	24Z731	277069	246428	277069	277070	24B748	277068	
PACKING REPAIR KIT	18B260	248212	244194	248212	248213	288471	246341	
CARBIDE SEAT KIT	246429	239922	246429	239922	244199	244199	240918	
PUMP ROD	24W617	248206	249125	248206	248207	288479	249000	
PUMP SLEEVE	24W619	248209	243176	248209	248210	248210	240921	
FILTER REPAIR KIT	-	-	287685	25A877	25A877	25A787	25A877	
CLUTCH REPAIR KIT	-	-	241109	241109	241113	-	-	
PINION HOUSING KIT	-	-	287376	287463	287465	-	-	
DRIVE HOUSING KIT	24W817	287284	-	287467	287469	-	-	
DISTANCE SENSOR KIT	-	15K357	-	15K357	15K357	-	15K357	
HYDRAULIC TRIP ROD/PISTON/CAP REPAIR KIT	-	-	-	-	-	288735	288754	
HYDRAULIC MOTOR REPAIR KIT	-	-	-	-	-	288758	248021	
HYDRAULIC MOTOR SEAL REPAIR KIT	-	-	-	-	-	246174	246174	
HYDRAULIC PUMP KIT (HD)	-	-	-	-	-	288733	287179	
HYDRAULIC 1:1 PROPORTIONER KIT	-	-	-	-	-	-	-	
MIX MANIFOLD COMPLETE	-	-	-	-	-	-	-	
BPO SLAVE PUMP COMPLETE	-	-	-	-	-	-	-	
BPO SLAVE PUMP BEARING & WIPER KIT	-	-	-	-	-	-	-	
BPO SLAVE PUMP FOOT VALVE REPAIR KIT	-	-	-	-	-	-	-	
BPO SLAVE PUMP THROAT SEAL REPAIR KIT	-	-	-	-	-	-	-	
BPO SLAVE PUMP PISTON REPAIR KIT	-	-	-	-	-	-	-	
BAFFLE KETTLE REPAIR KIT	-	-	-	-	-	-	-	
TEMPERATURE CONTROL KIT	-	-	-	-	-	-	-	
PILOT REPAIR KIT	-	-	-	-	-	-	-	
THERMOPILE REPAIR KIT	-	-	-	-	-	-	-	
GAS VALVE REPAIR KIT	-	-	-	-	-	-	-	
IGNITER REPAIR KIT	-	-	-	-	-	-	-	
COMPLETE PILOT/THERMOPILE REPAIR KIT	-	-	-	-	-	-	-	

Repair Parts

	LINELAZER V 250SPS/DC	LINELAZER V 200mma 1:1	LINELAZER V 250mma 98:2	LINEDRIVER 160	LINEDRIVER HD 200	LINEDRIVER ES	ROADPAK	THERMOLAZER 200tc	THERMOLAZER 300tc	THERMOLAZER ProMelt
	277068	277068	277068	-	-	-	287834	-	-	-
	246341	246341	246341	-	-	-	287835	-	-	-
	240918	240918	240918	-	-	-	287838	-	-	-
	249000	249000	249000	-	-	-	287832	-	-	-
	240921	240921	240921	-	-	-	287833	-	-	-
	24N517	25A877	24N517	-	-	-	-	-	-	-
	-	-	-	116875	247631	-	-	-	-	-
	-	-	-	-	-	-	-	-	-	-
	-	-	-	-	-	-	-	-	-	-
	15K357	15K357	15K357	-	-	-	-	-	-	-
	288754	288754	288754	-	-	-	-	-	-	-
	248021	248021	248021	-	-	-	-	-	-	-
	246174	246174	246174	-	-	-	287870	-	-	-
	16X083	287179	16X083	247930	247930	-	24J517 (17V283)	-	-	-
	-	131818	-	-	-	-	-	-	-	-
	-	-	17H095	-	-	-	-	-	-	-
	-	-	17H093	-	-	-	-	-	-	-
	-	-	16P185	-	-	-	-	-	-	-
	-	-	16N961	-	-	-	-	-	-	-
	-	-	16N963	-	-	-	-	-	-	-
	-	-	16N964	-	-	-	-	-	-	-
	-	-	-	-	-	-	-	-	-	24J571
	-	-	-	-	-	-	-	17B232	24C397	24J569
	-	-	-	-	-	-	-	24J574	24J575	24J574
	-	-	-	-	-	-	-	122944	122944	122944
	-	-	-	-	-	-	-	17B233	16F638	16F638
	-	-	-	-	-	-	-	-	123085	123085
	-	-	-	-	-	-	-	24U190	24U190	24T749

▶ WARRANTY



► **Warranty**

	5 YEARS	2 YEARS	1 YEAR
UNITS			
CART		CONTROL BOX & COMPONENTS	FLUID SECTION
DRIVE SYSTEM		ELECTRIC COMPONENTS	HYDRAULIC GROUP
HYDRAULIC MOTOR HARD PARTS		CLUTCH	GAS GROUP
		PUMP LOWER HARD PARTS	

ACCESSORIES

			GUN BODIES & ATTACHMENTS
--	--	--	--------------------------

WEAR ITEMS

			Graco does not cover wear items: tips, filters, sleeves, rods, packings, repair kits, seats, balls, brushes, dies, ...
--	--	--	--

OTHER WARRANTIES

			<p>Components not manufactured by Graco are covered by their own warranties: gasoline engines, hoses and batteries. All Graco products are covered by a one year warranty period against manufacturing defects. Consult our "Blue Book" (Form No. B0170) for complete detailed information on Graco's policies (warranty, freight, returns, etc.).</p> <p>3-Year Warranty on Lithium batteries of the ES range</p>
--	--	--	--



OUR PROMISE TO YOU

Since 1926, **innovation**, **quality** and **A+ service** have been at the centre of Graco.

Experience innovation

Our focus on innovation results in products and equipment that lead the industry with technologically-advanced features, pioneering design, high performance and unparalleled reliability. In short, innovation is how you get better products!

Building quality

You are investing in high-quality products built to last for years of reliable service. Moreover, we partner with our customers to better understand how you're deploying our products in the field, then use your experiences to improve performance and durability.



A+ service, every time

You'll see A+ Service in action when you contact any of our support services options no matter where you are in the world. We'll listen to your situation and work methodically to resolve it as quickly as we can. We are guided by a mindset of integrity and a customer service view centred on collaboration and relationships, not transactions.



We are here to answer questions and help address your needs.

www.graco.com/contact

Graco is ISO 9001 certified.

©2015 Graco Distribution BV 300720ENEU-J 12/23 Printed in Europe.

All written and visual data contained in this document are based on the latest product information available at the time of publication. Graco reserves the right to make changes at any time without notice.

All other brand names or marks are used for identification purposes and are trademarks of their respective owners. For more information on Graco's intellectual property, see www.graco.com/patent or www.graco.com/trademarks.